



CASEMENT WINDOWS

Technical Guide B

FEATURES & SPECIFICATIONS

Styles

Traditional, Push Out and Mission® options.

Standard Features

Natural, clear Douglas Fir interior (no visible finger joints)

4 9/16" (116 mm) jamb construction

LowE insulated glazing with 1/2" (13 mm) airspace

Roto gear operator and concealed sash locks

Extruded aluminum cladding in a variety of standard colors, primed wood or clear fir exterior

Flexible continuous weatherstrip system

Insect screens

Metal handle, cover and locks

Hardware

Operator and sash locks are available in a variety of types and finishes, see section A. Standard Casement sash opens out to nearly 90 degrees for ease of cleaning. The roto gear operator will hold the sash at any position in its operating radius. The sash is supported by concealed heavy duty hinges. All steel components are coated for superior corrosion protection.

Glazing

LowE Double, LowE Triple, Tranquility® and StormForce™. StormForce is not available on all products. Double or triple glass configurations with 1/2" (13 mm) airspace. With countless glazing configurations and LowE coating options, we ensure that you can choose the perfect blend of protection and comfort. LowE best describes the benefits of the product that incorporates glazing coatings and Argon gas. LowE systems help reduce heating and cooling costs, providing superior energy efficiency.



Traditional



Push Out Casement



Mission® Casement

FEATURES & SPECIFICATIONS

Simulated Divided Lites (SDL)

Standard SDL complete with airspace grilles, where available. Grille bars are permanently applied to the interior and exterior.

Ogee Profile – 3/4" (19 mm), 1 1/8" (30 mm), 2" (51 mm)

Putty Profile – 5/8" (16 mm), 7/8" (22 mm), 1 1/8" (30 mm), 2" (51 mm)

Square Profile (interior only) – 5/8" (16mm), 3/4" (19 mm), 7/8" (22 mm), 1 1/8" (30 mm), 2" (51 mm)

Casing

Wood: 2" (51 mm) Brickmould, 3 1/2" (89 mm) Flat, 5 1/2" (139 mm) Flat, Adams and Williamsburg.

Metal Clad: 2" (51 mm) Brickmould, 3 1/2" (89 mm) Flat, 2" clad frame extension, Nose & Cove, Adams, Williamsburg and Kerf.

Metal Cladding

Heavy duty exterior metal cladding comprised of extruded aluminum is available in a variety of Palette colors, including anodized and Cyprium (copper and bronze cladding). Metal clad units are supplied ready-to-install complete with integral metal nailing flange.

Wood

In addition to our standard Coastal Douglas Fir, the entire Loewen product line is also available in optional Mahogany. The interior can be natural wood (unfinished), primed, or prefinished in Jet Black or Oxford White paint. Additional wood species, as well as the Jet Black and Oxford White prefinishes, are available through our Custom Shop. All wood parts are dipped in approved preservative.

Performance Standards

Most units have been tested by an independent laboratory for air and water infiltration, structural performance, and thermal performance requirements.

Frame & Sash

Manufactured from Coastal Douglas Fir kiln-dried lumber with frame construction designed for 4 9/16" (116 mm) jamb. All wood exterior components are factory primed unless specified as clear exterior. Minor scratches or abrasions in the wood surface or primer are not considered defects.

Double Weatherstrip

The combination of a continuous, flexible foam weatherstrip and a flexible automotive type bulb weatherstrip ensures maximum energy efficiency and protection against air and water infiltration.

FEATURES & SPECIFICATIONS

Screen

Screens available in Alpine White, White, Linen, Tuscany Brown, Midnight Bronze, Steel Matte Black, Bronze, or Brushed Aluminum frame, screened with anti-glare fiberglass cloth. Wood-framed screens and High Transparency mesh available. Optional Retractable Screen and Swinging Screen available. Swinging Screen available on Push Out models only.

Egress

Consult local building codes for confirmation of size requirements for your area. Special egress hardware is available for Casement windows, which enables some sizes to meet egress codes, eliminating the need to go to the next larger size window. Consult your Authorized Loewen Dealer for more details.

Hardware Styles	Traditional Casement	Mission® Casement	French Casement	Push Out Casement
Folding Crank Handle	●	●		
Push Out Handle			●	●
Multipoint Lock	●	●	●	●

Standard ● **Optional** ○ Finish Options: Refer to Section A.

Variables	Traditional Casement	Mission® Casement	French Casement	Push Out Casement
Function				
Use for Egress	●	●	●	●
Available with Screen	●	●	●	●
Concealed Hardware	●	●	●	
Performance				
LowE Double	●	●	●	●
LowE Triple	○	○	○	○
StormForce™	○	○		○
Appearance				
SDL	○	○	○	○

Visit the Loewen Photo Gallery online at www.loewen.com for a large collection of Loewen product and elevation photography.

Numerous custom window configuration opportunities exist – please contact your Authorized Loewen Dealer.

Specifications and technical information are subject to change without notice. Imperial and metric measurements are converted accurately. However, in some cases, industry standards cause a 1 mm variance. (Example: 3/4" is shown as 19 mm for all glass measurements.) CAD Download: www.loewen.com/architect | Installation Instructions: www.loewen.com

**Casement
1 Wide Window Sizes**

Rough Opening		Width								
		Frame		16 1/2 [419]	20 7/16 [519]	24 3/8 [619]	28 5/16 [719]	30 1/4 [769]	32 1/4 [819]	36 3/16 [919]
		Wood Exterior	Metal Clad	Visible Glass	9 3/4 [247]	13 11/16 [347]	17 5/8 [447]	21 9/16 [547]	23 1/2 [597]	25 1/2 [647]
25 1/16 [636]	24 3/8 [619]	23 5/8 [600]	17 3/8 [442]	CA1 0406	CA1 0506	CA1 0606	CA1 0706	CA1 7506		
29 [736]	28 5/16 [719]	27 9/16 [700]	21 5/16 [542]	CA1 0407	CA1 0507	CA1 0607	CA1 0707	CA1 7507	CA1 0807	
30 15/16 [786]	30 1/4 [769]	29 1/2 [750]	23 5/16 [592]	CA1 0475	CA1 0575	CA1 0675	CA1 0775	CA1 7575	CA1 0875	
32 15/16 [836]	32 1/4 [819]	31 1/2 [800]	25 1/4 [642]	CA1 0408	CA1 0508	CA1 0608	CA1 0708	CA1 7508	CA1 0808	CA1 0908
36 7/8 [936]	36 3/16 [919]	35 7/16 [900]	29 3/16 [742]	CA1 0409	CA1 0509	CA1 0609	CA1 0709	CA1 7509	CA1 0809	CA1 0909
40 13/16 [1036]	40 1/8 [1019]	39 3/8 [1000]	33 1/8 [842]	CA1 0410	CA1 0510	CA1 0610	CA1 0710	CA1 7510	CA1 0810	CA1 0910
42 11/16 [1084]	42 [1067]	41 1/4 [1048]	35 1/16 [890]	CA1 0411	CA1 0511	CA1 0611	CA1 0711	CA1 7511	CA1 0811	CA1 0911
48 11/16 [1236]	48 [1219]	47 1/4 [1200]	41 [1042]	CA1 0412	CA1 0512	CA1 0612	CA1 0712	CA1 7512	CA1 0812	CA1 0912
56 9/16 [1436]	55 7/8 [1419]	55 1/8 [1400]	48 7/8 [1242]	CA1 0414	CA1 0514	CA1 0614	CA1 0714	CA1 7514	CA1 0814	CA1 0914
60 1/2 [1536]	59 13/16 [1519]	59 1/16 [1500]	52 13/16 [1342]	CA1 0415	CA1 0515	CA1 0615	CA1 0715	CA1 7515	CA1 0815	CA1 0915
64 7/16 [1636]	63 3/4 [1619]	63 [1600]	56 3/4 [1442]	CA1 0416	CA1 0516	CA1 0616	CA1 0716	CA1 7516	CA1 0816	CA1 0916
72 5/16 [1836]	71 5/8 [1819]	70 7/8 [1800]	64 5/8 [1642]	CA1 0418	CA1 0518	CA1 0618	CA1 0718	CA1 7518	CA1 0818	CA1 0918
84 1/8 [2136]	83 7/16 [2119]	82 11/16 [2100]	76 7/16 [1942]	CA1 0421	CA1 0521	CA1 0621	CA1 0721	CA1 7521	CA1 0821	CA1 0921

New oversized CA operator up to CA1 1224
 • watch for sizes where temp, tri sash, sash stabilizer etc. are read
 • roto only

Product Code

Glass Size = Visible Glass + 15/16" (24 mm)

Standard sizes Shown. Additional sizes may be available. Custom sizes can be ordered.

- Note:**
- Available with Mission sash. For a unit with a Mission sash, subtract 13/16" (21 mm) from the vertical visible glass measurement.
 - SDL/Grille patterns are dependent on SDL/Grille type and window size. Please verify SDL/Grille patterns before confirming your order.
 - Available with Push Out hardware.
 - For Masonry opening information see page Section A.
 - Sizes are shown as double glazing, not all sizes may be available in triple glazing.
 - Egress calculations are based on a 20" width opening. Opening does not open a full 90°.
 - ★ Meets US Egress: 20" in width, 24" in height, with a total egress area of 5.7 Sq Ft.
 - ✦ Meets Canadian Egress: 15" in width, 15" in height, with a total egress area of 3.8 Sq Ft.
 - Please check your local building codes for any variation in Egress Standards from those stated above. For egress information, contact your Authorized Loewen Dealer.

**Casement
2 Wide Window Sizes**

Rough Opening		Width								
		Frame		32 1/4 [819]	40 1/8 [1019]	48 [1219]	55 7/8 [1419]	59 13/16 [1519]	63 3/4 [1619]	71 5/8 [1819]
		Wood Exterior	Metal Clad	Visible Glass	9 3/4 [247]	13 11/16 [347]	17 5/8 [447]	21 9/16 [547]	23 1/2 [597]	25 1/2 [647]
25 1/16 [636]	24 3/8 [619]	23 5/8 [600]	17 3/8 [442]	CA2 0806	CA2 1006	CA2 1206	CA2 1406	CA2 1506		
29 [736]	28 5/16 [719]	27 9/16 [700]	21 5/16 [542]	CA2 0807	CA2 1007	CA2 1207	CA2 1407	CA2 1507	CA2 1607	
30 15/16 [786]	30 1/4 [769]	29 1/2 [750]	23 5/16 [592]	CA2 0875	CA2 1075	CA2 1275	CA2 1475	CA2 1575	CA2 1675	
32 15/16 [836]	32 1/4 [819]	31 1/2 [800]	25 1/4 [642]	CA2 0808	CA2 1008	CA2 1208	CA2 1408	CA2 1508	CA2 1608	CA2 1808
36 7/8 [936]	36 3/16 [919]	35 7/16 [900]	29 3/16 [742]	CA2 0809	CA2 1009	CA2 1209	CA2 1409	CA2 1509	CA2 1609	CA2 1809
40 13/16 [1036]	40 1/8 [1019]	39 3/8 [1000]	33 1/8 [842]	CA2 0810	CA2 1010	CA2 1210	CA2 1410	CA2 1510	CA2 1610	CA2 1810
42 11/16 [1084]	42 [1067]	41 1/4 [1048]	35 1/16 [890]	CA2 0811	CA2 1011	CA2 1211	CA2 1411	CA2 1511	CA2 1611	CA2 1811
48 11/16 [1236]	48 [1219]	47 1/4 [1200]	41 [1042]	CA2 0812	CA2 1012	CA2 1212	CA2 1412	CA2 1512	CA2 1612	CA2 1812
56 9/16 [1436]	55 7/8 [1419]	55 1/8 [1400]	48 7/8 [1242]	CA2 0814	CA2 1014	CA2 1214	CA2 1414	CA2 1514	CA2 1614	CA2 1814
60 1/2 [1536]	59 13/16 [1519]	59 1/16 [1500]	52 13/16 [1342]	CA2 0815	CA2 1015	CA2 1215	CA2 1415	CA2 1515	CA2 1615	CA2 1815
64 7/16 [1636]	63 3/4 [1619]	63 [1600]	56 3/4 [1442]	CA2 0816	CA2 1016	CA2 1216	CA2 1416	CA2 1516	CA2 1616	CA2 1816
72 5/16 [1836]	71 5/8 [1819]	70 7/8 [1800]	64 5/8 [1642]	CA2 0818	CA2 1018	CA2 1218	CA2 1418	CA2 1518	CA2 1618	CA2 1818
84 1/8 [2136]	83 7/16 [2119]	82 11/16 [2100]	76 7/16 [1942]	CA2 0821	CA2 1021	CA2 1221	CA2 1421	CA2 1521	CA2 1621	CA2 1821

Product Code

Glass Size = Visible Glass + 15/16" (24 mm)

Standard sizes Shown. Additional sizes may be available. Custom sizes can be ordered.

- Note:**
- Available with Mission sash. For a unit with a Mission sash, subtract 13/16" (21 mm) from the vertical visible glass measurement.
 - SDL/Grille patterns are dependent on SDL/Grille type and window size. Please verify SDL/Grille patterns before confirming your order.
 - Available with Push Out hardware.
 - For Masonry opening information see page Section A.
 - Sizes are shown as double glazing, not all sizes may be available in triple glazing.
 - Egress calculations are based on a 20" width opening. Opening does not open a full 90°.
 - ★ Meets US Egress: 20" in width, 24" in height, with a total egress area of 5.7 Sq Ft.
 - ✦ Meets Canadian Egress: 15" in width, 15" in height, with a total egress area of 3.8 Sq Ft.
 - Please check your local building codes for any variation in Egress Standards from those stated above. For egress information, contact your Authorized Loewen Dealer.

French Casement Window Sizes

Width

Rough Opening		Width										
		Frame										
		Wood Exterior	Metal Clad	Visible Glass								
		32 1/4" [819]	40 1/8" [1019]	41 1/8" [1044]	42" [1067]	48" [1219]	55 7/8" [1419]	59 13/16" [1519]	63 3/4" [1619]	71 5/8" [1819]		
		31 1/2" [800]	39 3/8" [1000]	40 3/8" [1025]	41 1/4" [1048]	47 1/4" [1200]	55 1/8" [1400]	59 1/16" [1500]	63" [1600]	70 7/8" [1800]		
		10 5/16" [262]	14 1/4" [362]	14 3/4" [374]	15 3/16" [386]	18 3/16" [462]	22 1/8" [562]	24 1/8" [612]	26 1/16" [662]	30" [762]		
25 1/16" [636]	24 3/8" [619]	23 5/8" [600]	17 3/8" [442]	FCA + 0806	FCA + 1006		FCA + 1106	FCA + 1206	FCA + 1406			
29" [736]	28 5/16" [719]	27 9/16" [700]	21 5/16" [542]	FCA + 0807	FCA + 1007		FCA + 1107	FCA + 1207	FCA + 1407	FCA + 1507	FCA + 1607	
32 15/16" [836]	32 1/4" [819]	31 1/2" [800]	25 1/4" [642]	FCA + 0808	FCA + 1008	FCA * 1008	FCA 1108	FCA 1208	FCA 1408	FCA 1508	FCA 1608	FCA + 1808
36 7/8" [936]	36 3/16" [919]	35 7/16" [900]	29 3/16" [742]	FCA + 0809	FCA + 1009	FCA * 1009	FCA 1109	FCA 1209	FCA 1409	FCA 1509	FCA 1609	FCA 1809
40 13/16" [1036]	40 1/8" [1019]	39 3/8" [1000]	33 1/8" [842]	FCA + 0810	FCA + 1010	FCA * 1010	FCA 1110	FCA 1210	FCA 1410	FCA 1510	FCA 1610	FCA 1810
42 11/16" [1084]	42" [1067]	41 1/4" [1048]	35 1/16" [890]	FCA + 0811	FCA + 1011	FCA * 1011	FCA 1111	FCA 1211	FCA 1411	FCA 1511	FCA 1611	FCA 1811
48 11/16" [1236]	48" [1219]	47 1/4" [1200]	41" [1042]	FCA + 0812	FCA + 1012	FCA * 1012	FCA 1112	FCA 1212	FCA 1412	FCA 1512	FCA 1612	FCA 1812
56 9/16" [1436]	55 7/8" [1419]	55 1/8" [1400]	48 7/8" [1242]	FCA + 0814	FCA + 1014	FCA * 1014	FCA 1114	FCA 1214	FCA 1414	FCA 1514	FCA 1614	FCA 1814
60 1/2" [1536]	59 13/16" [1519]	59 1/16" [1500]	52 13/16" [1342]	FCA + 0815	FCA + 1015	FCA * 1015	FCA 1115	FCA 1215	FCA 1415	FCA 1515	FCA 1615	FCA 1815
64 7/16" [1636]	63 3/4" [1619]	63" [1600]	56 3/4" [1442]	FCA + 0816	FCA + 1016	FCA * 1016	FCA 1116	FCA 1216	FCA 1416	FCA 1516	FCA 1616	FCA 1816
72 5/16" [1836]	71 5/8" [1819]	70 7/8" [1800]	64 5/8" [1642]	FCA + 0818	FCA + 1018	FCA * 1018	FCA 1118	FCA 1218	FCA 1418	FCA 1518	FCA * 1618	FCA * 1818

Height

Product Code

Glass Size = Visible Glass + 15/16" (24 mm)

* Only available with rotogear hardware

+ Only available with pushout hardware

Standard sizes Shown. Additional sizes may be available. Custom sizes can be ordered.

Note: • Available with Mission sash. For a unit with a Mission sash, subtract 13/16" (21 mm) from the vertical visible glass measurement.
 • SDL/Grille patterns are dependent on SDL/Grille type and window size. Please verify SDL/Grille patterns before confirming your order.
 • For Masonry opening information see page Section A.
 • Sizes are shown as double glazing, not all sizes may be available in triple glazing.

• Egress calculations are based on a 20" width opening. Opening does not open a full 90°.

- ★ Meets US Egress: 20" in width, 24" in height, with a total egress area of 5.7 Sq Ft.
- ♣ Meets Canadian Egress: 15" in width, 15" in height, with a total egress area of 3.8 Sq Ft.

 • Please check your local building codes for any variation in Egress Standards from those stated above. For egress information, contact your Authorized Loewen Dealer.

Camber Top Casement 1 Wide Window Sizes

Width

Rough Opening				Width							
				Frame							
				Wood Exterior	Metal Clad	Visible Glass					
				16 1/2" [419]	20 7/16" [519]	24 3/8" [619]	28 5/16" [719]	30 1/4" [769]	32 1/4" [819]	36 3/16" [919]	
				15 3/4" [400]	19 11/16" [500]	23 5/8" [600]	27 9/16" [700]	29 1/2" [750]	31 1/2" [800]	35 7/16" [900]	
				9 3/4" [247]	13 11/16" [347]	17 5/8" [447]	21 9/16" [547]	23 1/2" [597]	25 1/2" [647]	29 7/16" [747]	
29" [736]	28 5/16" [719]	27 9/16" [700]	21 3/16" [538]	CTC1 0407	CTC1 0507	CTC1 0607	CTC1 0707	CTC1 7507	CTC1 0807		
30 15/16" [786]	30 1/4" [769]	29 1/2" [750]	23 5/8" [588]	CTC1 0475	CTC1 0575	CTC1 0675	CTC1 0775	CTC1 7575	CTC1 0875		
32 15/16" [836]	32 1/4" [819]	31 1/2" [800]	25 1/8" [638]	CTC1 0408	CTC1 0508	CTC1 0608	CTC1 0708	CTC1 7508	CTC1 0808		
36 7/8" [936]	36 3/16" [919]	35 7/16" [900]	29 1/16" [738]	CTC1 0409	CTC1 0509	CTC1 0609	CTC1 0709	CTC1 7509	CTC1 0809	CTC1 0909	
40 13/16" [1036]	40 1/8" [1019]	39 3/8" [1000]	33" [838]	CTC1 0410	CTC1 0510	CTC1 0610	CTC1 0710	CTC1 7510	CTC1 0810	CTC1 0910	
42 11/16" [1084]	42" [1067]	41 1/4" [1048]	34 7/8" [886]	CTC1 0411	CTC1 0511	CTC1 0611	CTC1 0711	CTC1 7511	CTC1 0811	CTC1 0911	
48 11/16" [1236]	48" [1219]	47 1/4" [1200]	40 7/8" [1038]	CTC1 0412	CTC1 0512	CTC1 0612	CTC1 0712	CTC1 7512	CTC1 0812	CTC1 0912	
56 9/16" [1436]	55 7/8" [1419]	55 1/8" [1400]	48 3/4" [1238]	CTC1 0414	CTC1 0514	CTC1 0614	CTC1 0714	CTC1 7514	CTC1 0814	CTC1 0914	
60 1/2" [1536]	59 13/16" [1519]	59 1/16" [1500]	52 11/16" [1338]	CTC1 0415	CTC1 0515	CTC1 0615	CTC1 0715	CTC1 7515	CTC1 0815	CTC1 0915	
64 7/16" [1636]	63 3/4" [1619]	63" [1600]	56 5/8" [1438]	CTC1 0416	CTC1 0516	CTC1 0616	CTC1 0716	CTC1 7516	CTC1 0816	CTC1 0916	
72 5/16" [1836]	71 5/8" [1819]	70 7/8" [1800]	64 1/2" [1638]	CA1 0418	CTC1 0518	CTC1 0618	CTC1 0718	CTC1 7518	CTC1 0818	CTC1 0918	
84 1/8" [2136]	83 7/16" [2119]	82 11/16" [2100]	76 5/16" [1938]	CA1 0421	CTC1 0521	CTC1 0621	CTC1 0721	CTC1 7521	CTC1 0821	CTC1 0921	

Height

Product Code

Glass Size = Visible Glass + 15/16" (24 mm)

Standard sizes Shown. Additional sizes may be available. Custom sizes can be ordered.

Note: • Available with Mission sash. For a unit with a Mission sash, subtract 13/16" (21 mm) from the vertical visible glass measurement.
 • SDL/Grille patterns are dependent on SDL/Grille type and window size. Please verify SDL/Grille patterns before confirming your order.
 • For Masonry opening information see page Section A.
 • Sizes are shown as double glazing, not all sizes may be available in triple glazing.

**Camber Top Casement
2 Wide Window Sizes**

Width

Height

Rough Opening		Frame		Visible Glass		32 1/4" [819]	40 1/8" [1019]	48" [1219]	55 7/8" [1419]	59 13/16" [1519]	63 3/4" [1619]	71 5/8" [1819]
Wood Exterior	Metal Clad					31 1/2" [800]	39 3/8" [1000]	47 1/4" [1200]	55 1/8" [1400]	59 1/16" [1500]	63" [1600]	70 7/8" [1800]
						9 3/4" [247]	13 11/16" [347]	17 5/8" [447]	21 9/16" [547]	23 1/2" [597]	25 1/2" [647]	29 7/16" [747]
29" [736]	28 5/16" [719]	27 9/16" [700]	21 3/16" [538]	CTC2 0807	CTC2 1007	CTC2 1207	CTC2 1407	CTC2 1475	CTC2 1408			
30 15/16" [786]	30 1/4" [769]	29 1/2" [750]	23 5/8" [588]	CTC2 0875	CTC2 1075	CTC2 1275	CTC2 1475	CTC2 1575	CTC2 1508			
32 15/16" [836]	32 1/4" [819]	31 1/2" [800]	25 1/8" [638]	CTC2 0808	CTC2 1008	CTC2 1208	CTC2 1408	CTC2 1508	CTC2 1608			
36 7/8" [936]	36 3/16" [919]	35 7/16" [900]	29 1/16" [738]	CTC2 0809	CTC2 1009	CTC2 1209	CTC2 1409	CTC2 1509	CTC2 1609	CTC2 1809		
40 13/16" [1036]	40 1/8" [1019]	39 3/8" [1000]	33" [838]	CTC2 0810	CTC2 1010	CTC2 1210	CTC2 1410	CTC2 1510	CTC2 1610	CTC2 1810		
42 11/16" [1084]	42" [1067]	41 1/4" [1048]	34 7/8" [886]	CTC2 0811	CTC2 1011	CTC2 1211	CTC2 1411	CTC2 1511	CTC2 1611	CTC2 1811		
48 11/16" [1236]	48" [1219]	47 1/4" [1200]	40 7/8" [1038]	CTC2 0812	CTC2 1012	CTC2 1212	CTC2 1412	CTC2 1512	CTC2 1612	CTC2 1812		
56 9/16" [1436]	55 7/8" [1419]	55 1/8" [1400]	48 3/4" [1238]	CTC2 0814	CTC2 1014	CTC2 1214	CTC2 1414	CTC2 1514	CTC2 1614	CTC2 1814		
60 1/2" [1536]	59 13/16" [1519]	59 1/16" [1500]	52 11/16" [1338]	CTC2 0815	CTC2 1015	CTC2 1215	CTC2 1415	CTC2 1515	CTC2 1615	CTC2 1815		
64 7/16" [1636]	63 3/4" [1619]	63" [1600]	56 5/8" [1438]	CTC2 0816	CTC2 1016	CTC2 1216	CTC2 1416	CTC2 1516	CTC2 1616	CTC2 1816		
72 5/16" [1836]	71 5/8" [1819]	70 7/8" [1800]	64 1/2" [1638]	CTC2 0818	CTC2 1018	CTC2 1218	CTC2 1418	CTC2 1518	CTC2 1618	CTC2 1818		
84 1/8" [2136]	83 7/16" [2119]	82 11/16" [2100]	76 5/16" [1938]	CTC2 0821	CTC2 1021	CTC2 1221	CTC2 1421	CTC2 1521	CTC2 1621	CTC2 1821		

Product Code

Glass Size = Visible Glass + 15/16" (24 mm)

Standard sizes Shown. Additional sizes may be available. Custom sizes can be ordered.

- Note:
- Available with Mission sash. For a unit with a Mission sash, subtract 13/16" (21 mm) from the vertical visible glass measurement.
 - SDL/Grille patterns are dependent on SDL/Grille type and window size. Please verify SDL/Grille patterns before confirming your order.
 - For Masonry opening information see page Section A.
 - Sizes are shown as double glazing, not all sizes may be available in triple glazing.

**Camber Top Casement
Standard Radius Elevations**

Imperial

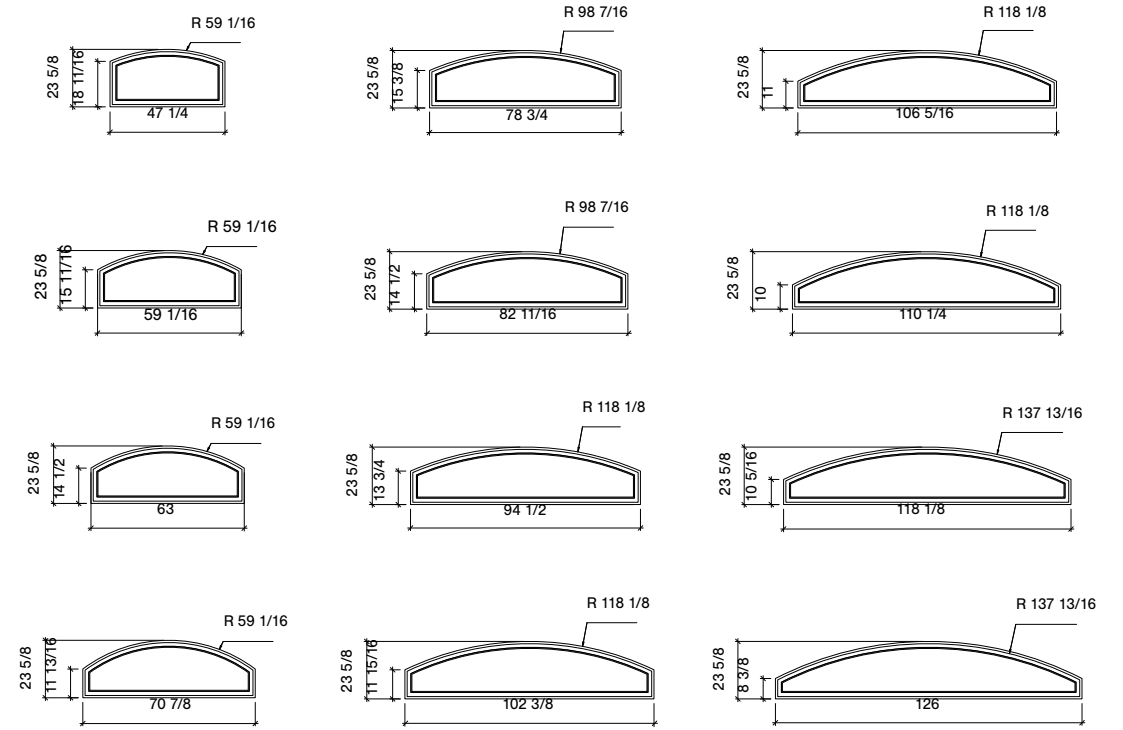

Metric

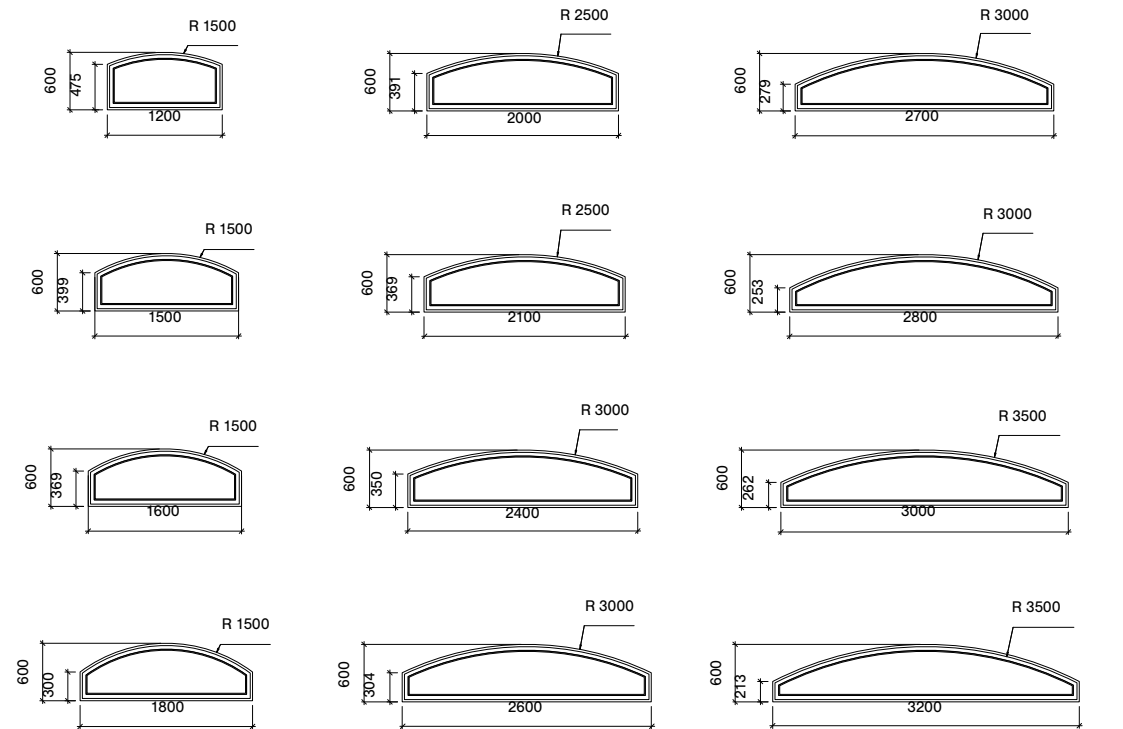

- Note:
- Other jamb widths available.
 - All dimensions to have +/- 1/16" (2mm) tolerance.

Half Round Casement Window Sizes

Rough Opening		Width						
		Frame						
		Wood Exterior	Metal Clad	Visible Glass				
		24 3/8" [619]	28 5/16" [719]	30 1/4" [769]	32 1/4" [819]	36 3/16" [919]		
		23 5/8" [600]	27 9/16" [700]	29 1/2" [750]	31 1/2" [800]	35 7/16" [900]		
		17 5/8" [447]	21 9/16" [547]	23 1/2" [597]	25 1/2" [647]	29 7/16" [747]		
40 13/16" [1036]	40 1/8" [1019]	39 3/8" [1000]	33 1/8" [842]	CA1 0610	CA1 0710			
42 11/16" [1084]	42" [1067]	41 1/4" [1048]	35 1/16" [890]	CA1 0611	CA1 0711			
48 11/16" [1236]	48" [1219]	47 1/4" [1200]	41" [1042]	CA1 0612	CA1 0712	CA1 7512	CA1 0812	
56 9/16" [1436]	55 7/8" [1419]	55 1/8" [1400]	48 7/8" [1242]	CA1 0614	CA1 0714	CA1 7514	CA1 0814	CA1 0914
60 1/2" [1536]	59 13/16" [1519]	59 1/16" [1500]	52 13/16" [1342]	CA1 0615	CA1 0715	CA1 7515	CA1 0815	CA1 0915
64 7/16" [1636]	63 3/4" [1619]	63" [1600]	56 3/4" [1442]	CA1 0616	CA1 0716	CA1 7516	CA1 0816	CA1 0916
72 5/16" [1836]	71 5/8" [1819]	70 7/8" [1800]	64 5/8" [1642]	CA1 0618	CA1 0718	CA1 7518	CA1 0818	CA1 0918
84 1/8" [2136]	83 7/16" [2119]	82 11/16" [2100]	76 7/16" [1942]	CA1 0621	CA1 0721	CA1 7521	CA1 0821	CA1 0921

Product Code

Glass Size = Visible Glass + 15/16" (24 mm)

Standard sizes Shown. Additional sizes may be available. Custom sizes can be ordered.

- Note:
- Available with Mission sash. For a unit with a Mission sash, subtract 13/16" (21 mm) from the vertical visible glass measurement.
 - SDL/Grille patterns are dependent on SDL/Grille type and window size. Please verify SDL/Grille patterns before confirming your order.
 - For Masonry opening information see page Section A.
 - Sizes are shown as double glazing, not all sizes may be available in triple glazing.

Oversized Casement Window (Roto Gear Only)

Rough Opening				Width											
				Frame											
				Wood Exterior	Metal Clad	Visible Glass									
				16 1/2" [419]	20 7/16" [519]	24 3/8" [619]	28 5/16" [719]	30 1/4" [769]	32 1/4" [819]	36 3/16" [919]	40 1/8" [1019]	42" [1067]	48" [1219]		
				15 3/4" [400]	19 11/16" [500]	23 5/8" [600]	27 9/16" [700]	29 1/2" [750]	31 1/2" [800]	35 7/16" [900]	39 3/8" [1000]	41 1/4" [1048]	47 1/4" [1200]		
				9 3/4" [247]	13 11/16" [347]	17 5/8" [447]	21 9/16" [547]	23 1/2" [597]	25 1/2" [647]	29 7/16" [747]	33 3/8" [847]	35 1/4" [895]	41 1/4" [1047]		
36 7/8" [936]	36 3/16" [919]	35 7/16" [900]	29 3/16" [742]										CA1 * 1009		
40 13/16" [1036]	40 1/8" [1019]	39 3/8" [1000]	33 1/8" [842]										CA1 * 1010	CA1 * 1110	
42 11/16" [1084]	42" [1067]	41 1/4" [1048]	35 1/16" [890]										CA1 * 1011	CA1 * 1111	
48 11/16" [1236]	48" [1219]	47 1/4" [1200]	41" [1042]										★ ★ CA1 * 1012	★ ★ CA1 * 1112	CA1 * 1212
56 9/16" [1436]	55 7/8" [1419]	55 1/8" [1400]	48 7/8" [1242]										★ ★ CA1 * 1014	★ ★ CA1 * 1114	CA1 * 1214
60 1/2" [1536]	59 13/16" [1519]	59 1/16" [1500]	52 13/16" [1342]										★ ★ CA1 * 1015	★ ★ CA1 * 1115	CA1 * 1215
64 7/16" [1636]	63 3/4" [1619]	63" [1600]	56 3/4" [1442]										★ ★ CA1 * 1016	★ ★ CA1 * 1116	CA1 * 1216
72 5/16" [1836]	71 5/8" [1819]	70 7/8" [1800]	64 5/8" [1642]										★ ★ CA1 * 1018	★ ★ CA1 * 1118	CA1 * 1218
84 1/8" [2136]	83 7/16" [2119]	82 11/16" [2100]	76 7/16" [1942]										★ ★ CA1 * 1021	★ ★ CA1 * 1121	CA1 * 1221
95 7/8" [2436]	95 1/4" [2419]	94 1/2" [2400]	88 1/4" [2242]	CA1* 0424	CA1* 0524	CA1* 0624	CA1* 0724	★ ★ CA1* 7524	★ ★ CA1* 0824	★ ★ CA1* 0924	★ ★ CA1 * 1024	★ ★ CA1 * 1124	CA1 * 1224		

Product Code

Glass Size = Visible Glass + 15/16" (24 mm)

*Only available with roto gear hardware

Standard sizes Shown. Additional sizes may be available. Custom sizes can be ordered.

- Note:
- Available with Mission sash. For a unit with a Mission sash, subtract 13/16" (21 mm) from the vertical visible glass measurement.
 - SDL/Grille patterns are dependent on SDL/Grille type and window size. Please verify SDL/Grille patterns before confirming your order.
 - Available with Push Out hardware.
 - For Masonry opening information see page Section A.
 - Sizes are shown as double glazing, not all sizes may be available in triple glazing.
 - Egress calculations are based on a 20" width opening. Opening does not open a full 90°.
 - ★ Meets US Egress: 20" in width, 24" in height, with a total egress area of 5.7 Sq Ft.
 - ♣ Meets Canadian Egress: 15" in width, 15" in height, with a total egress area of 3.8 Sq Ft.
 - Please check your local building codes for any variation in Egress Standards from those stated above. For egress information, contact your Authorized Loewen Dealer.

Contemporary Frame Cladding Detail

Head & Sill Detail

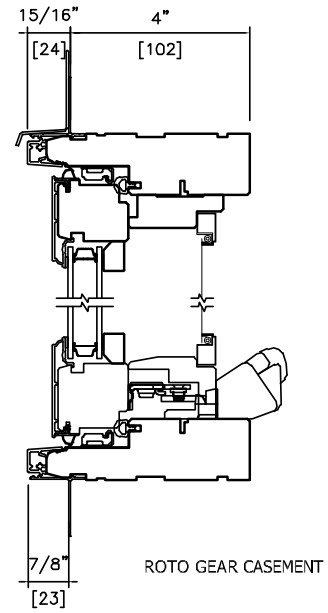

Casing

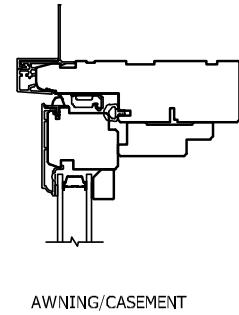

Casement Window Wall Connection Detail

Head & Sill Detail

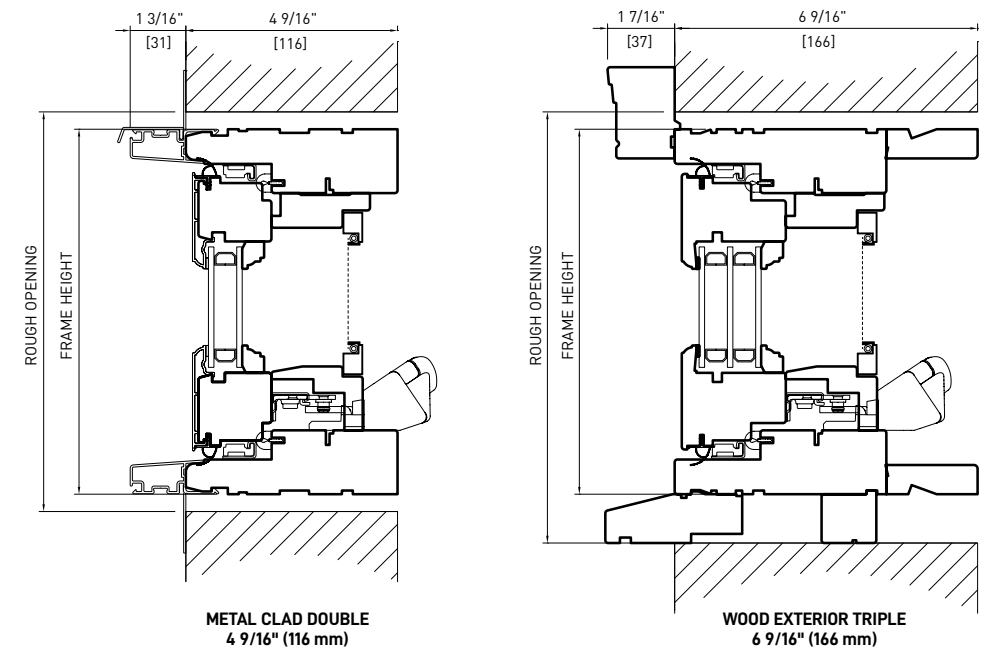

Plan View

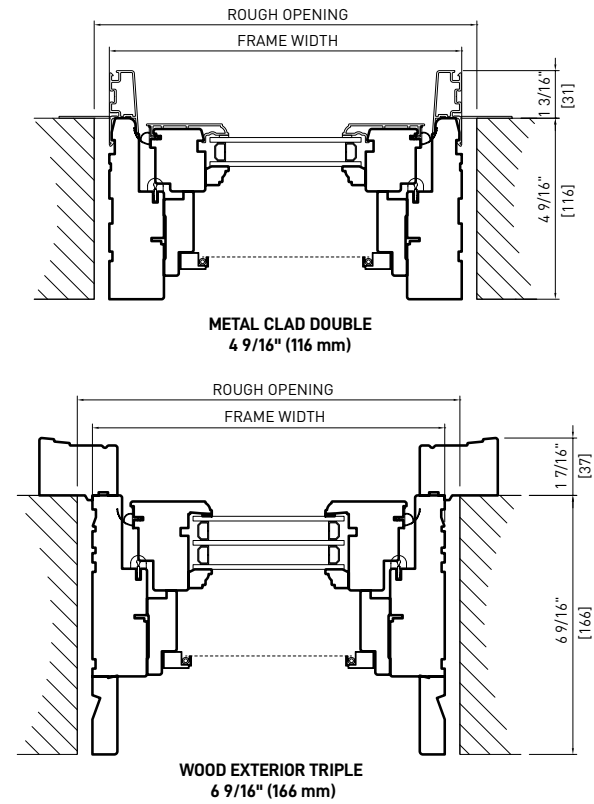

Note:

- Other jamb widths available.
- All dimensions to have +/- 1/16" (2mm) tolerance.

Casement Window Detail

Head & Sill Detail

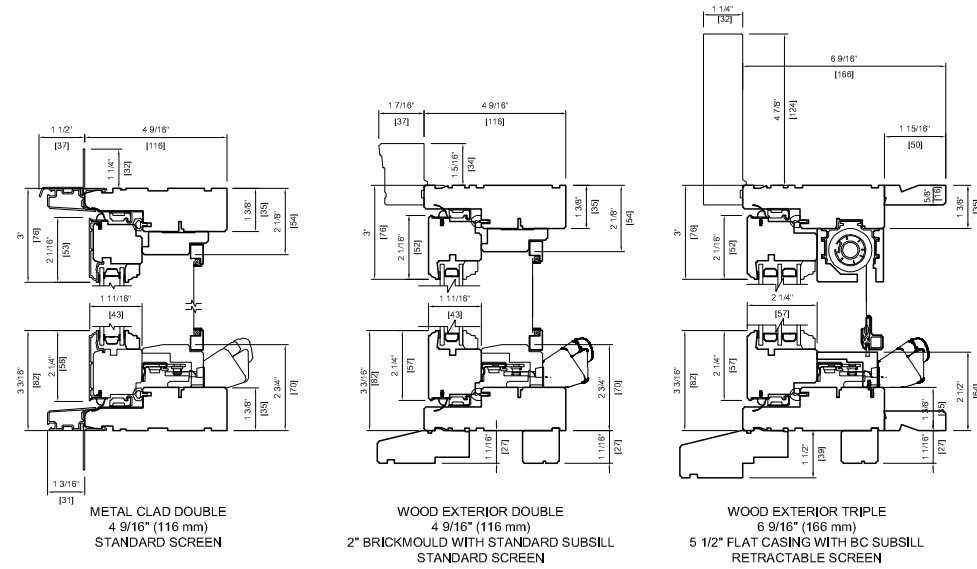

Push Out Casement Window Detail

Head & Sill Detail

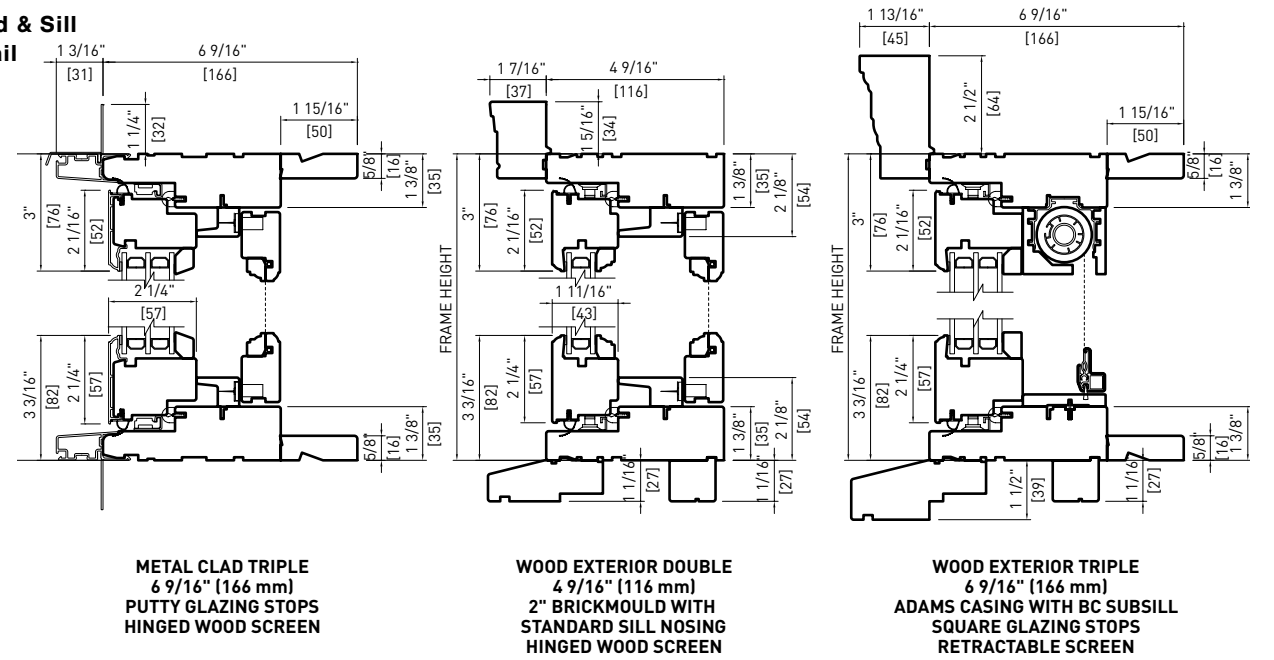

Head & Sill Detail

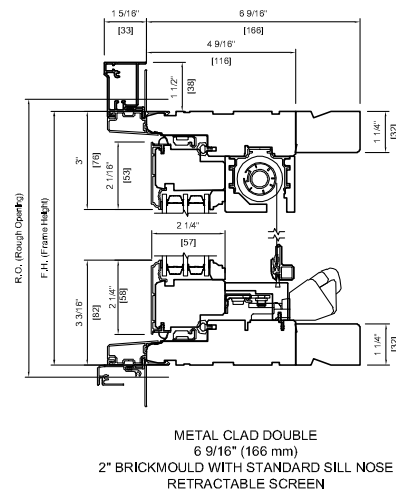

Plan View

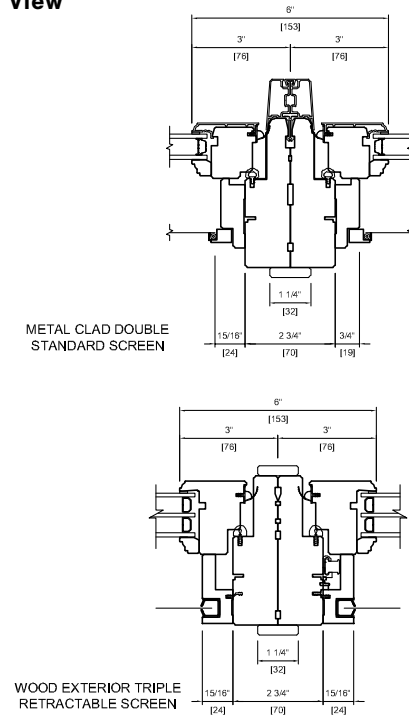

Head & Sill Detail

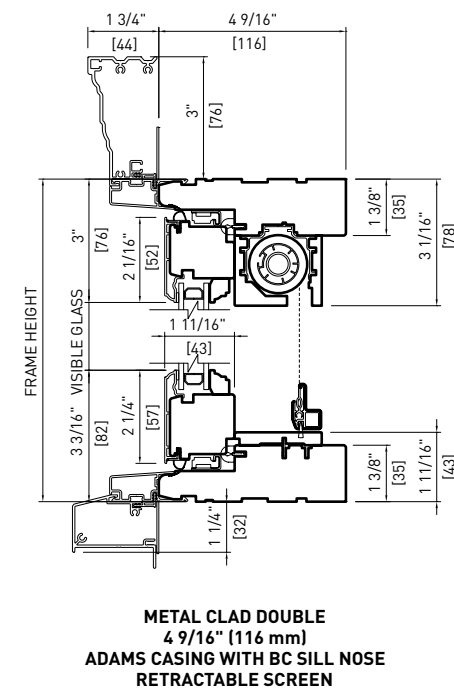

Plan View

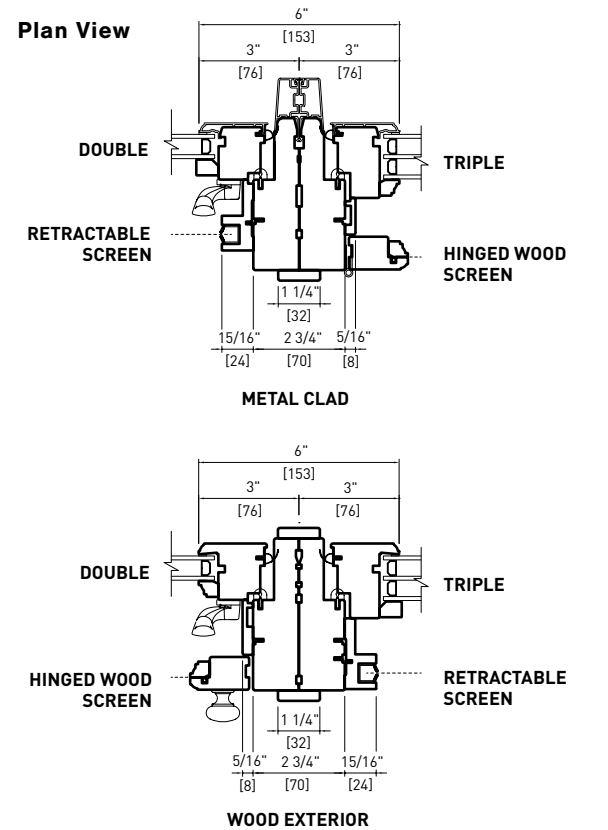

Note: • Other jamb widths available.
• All dimensions to have +/- 1/16" (2mm) tolerance.

Note: • Other jamb widths available.
• All dimensions to have +/- 1/16" (2mm) tolerance.

Fixed Casement Window Detail

Head & Sill Detail Roto Gear Sash Moulding Options

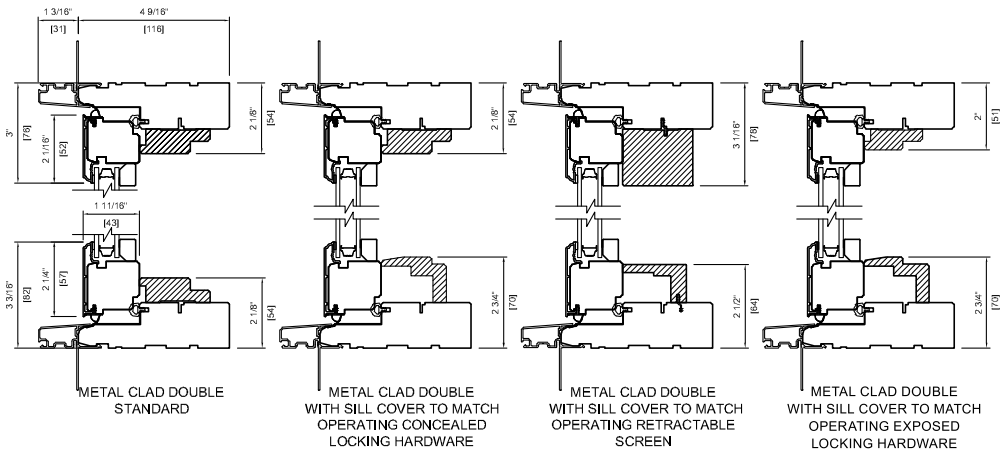

Glazing Stop Profiles

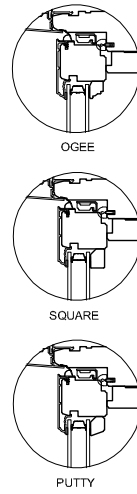

Mission Casement Window Detail

Head & Sill Detail

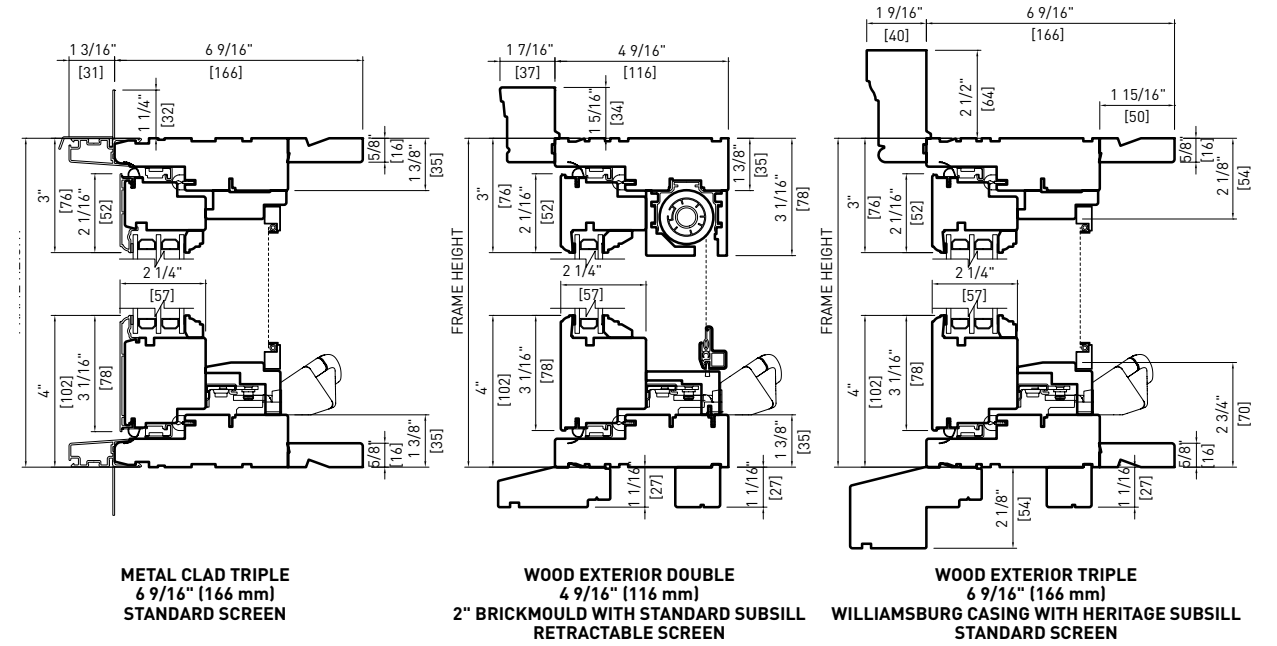

Head & Sill Detail Pushout - Sash Moulding Options

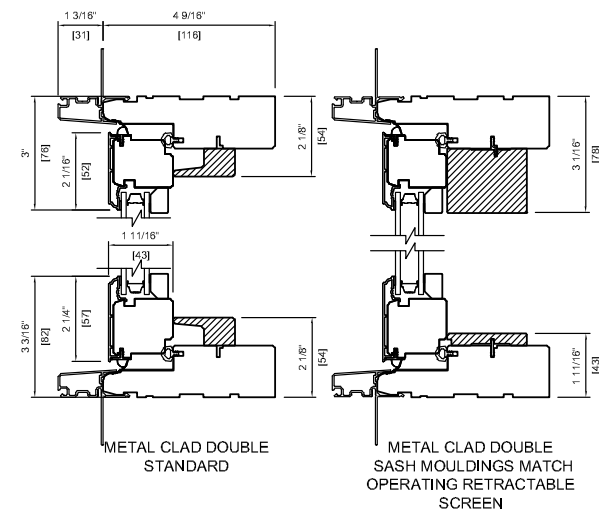

Head & Sill Detail Wood Exterior - Sash Moulding Options Are The Same As Metal Clad

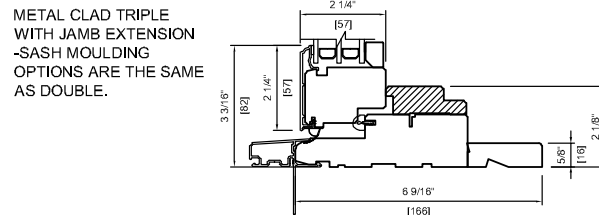
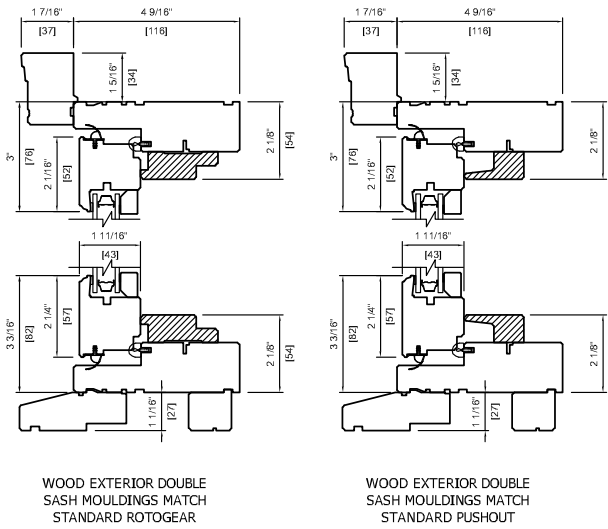

Head & Sill Detail

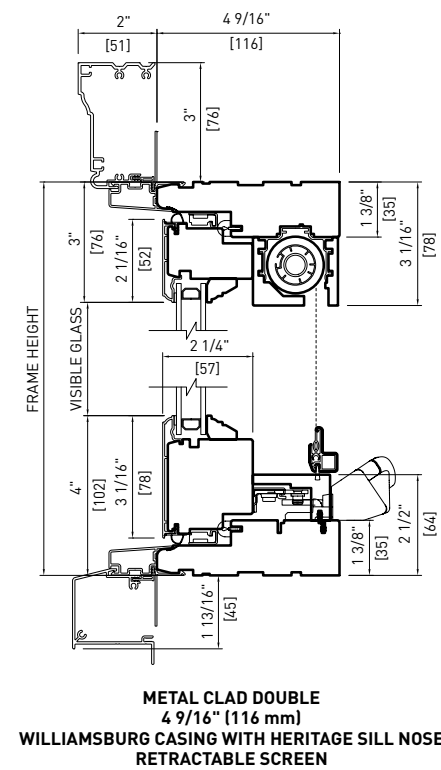

Plan View

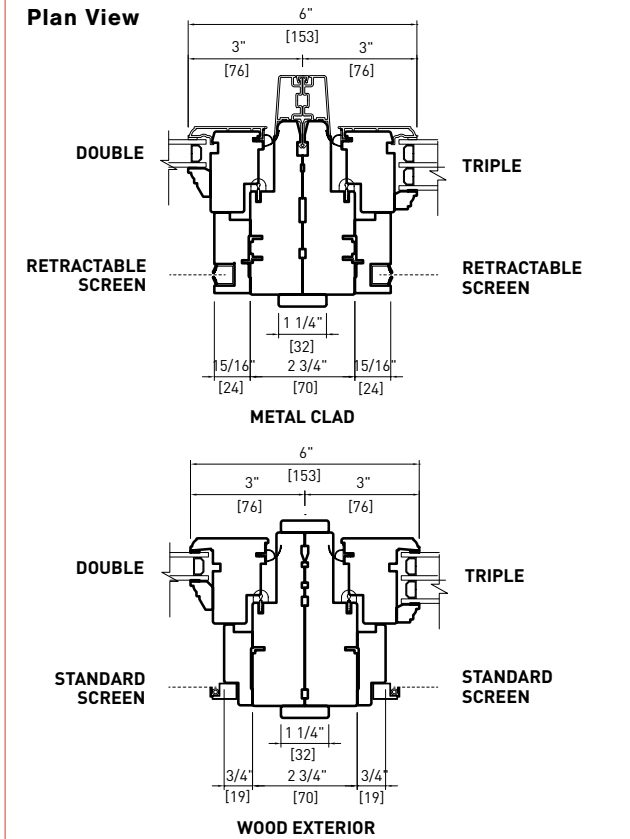

Note: • Other jamb widths available.
• All dimensions to have +/- 1/16" (2mm) tolerance.

Note: • Other jamb widths available.
• All dimensions to have +/- 1/16" (2mm) tolerance.

Push Out French Casement Window Detail

Head & Sill Detail

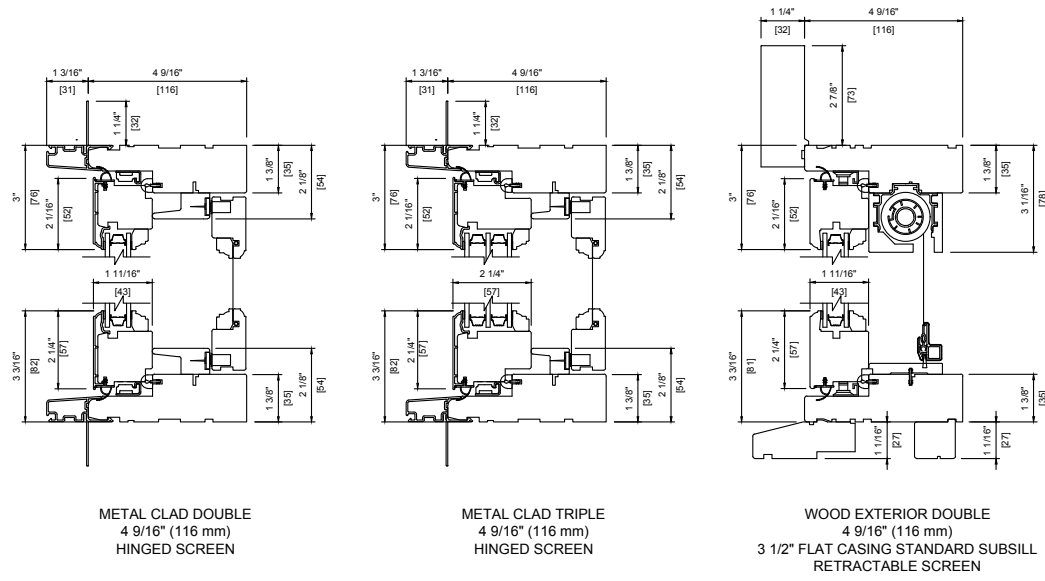

Glazing Stop Profiles

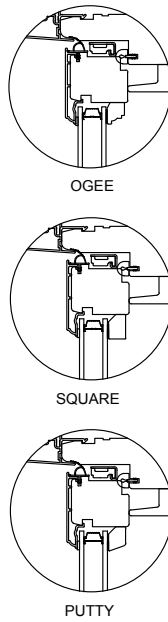

Radius Top Casement Window Detail

Head & Sill Detail

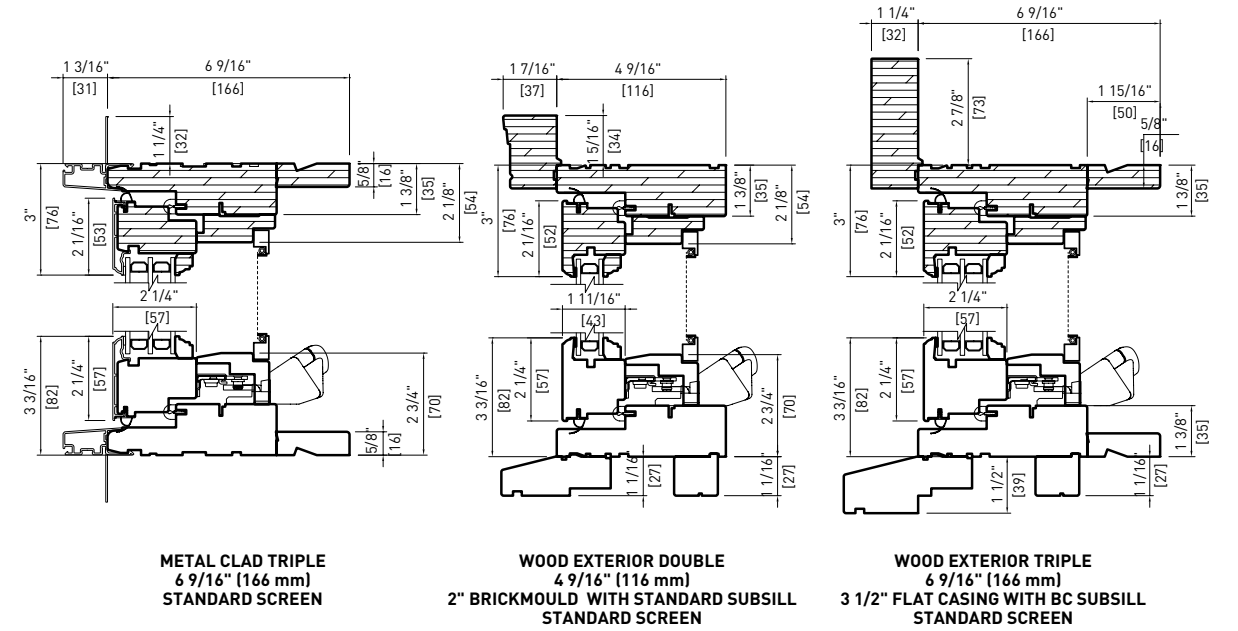

Plan View

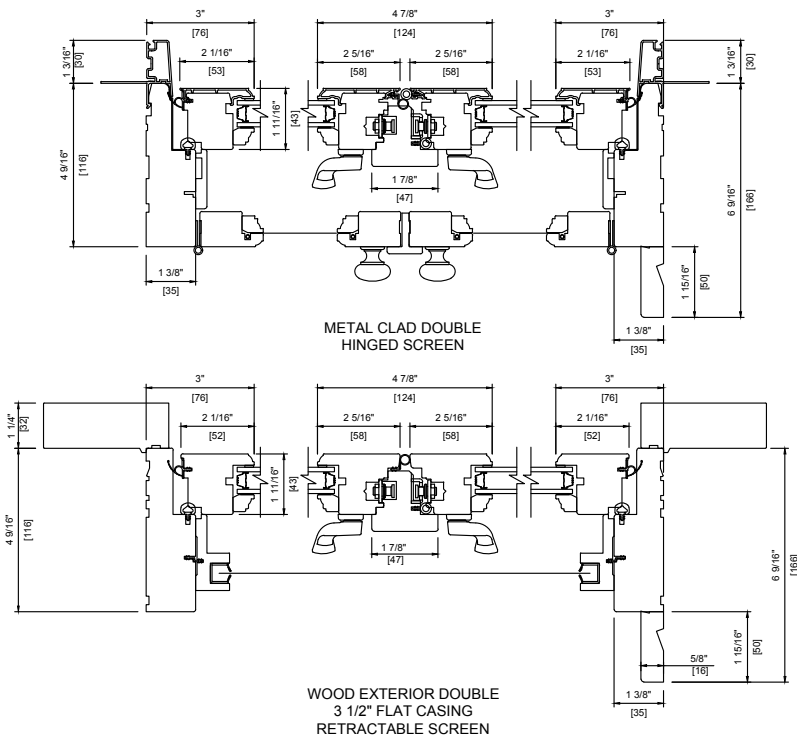

Casing

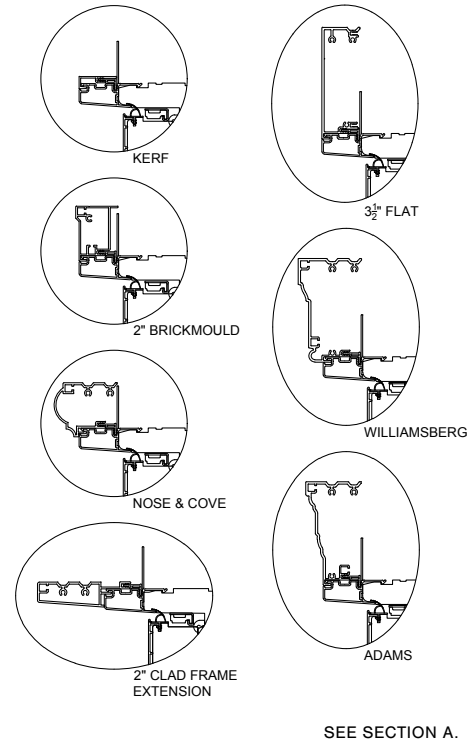

Head & Sill Detail

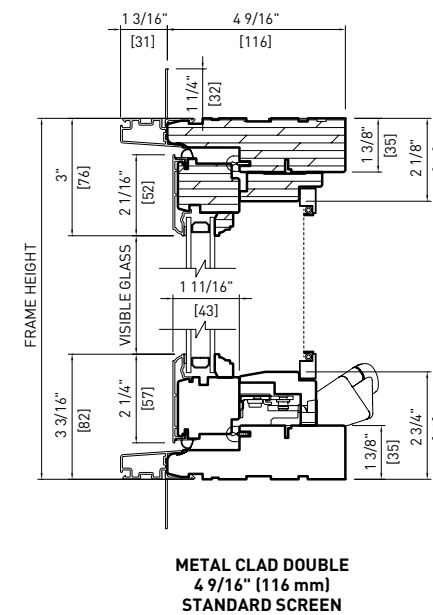

Plan View

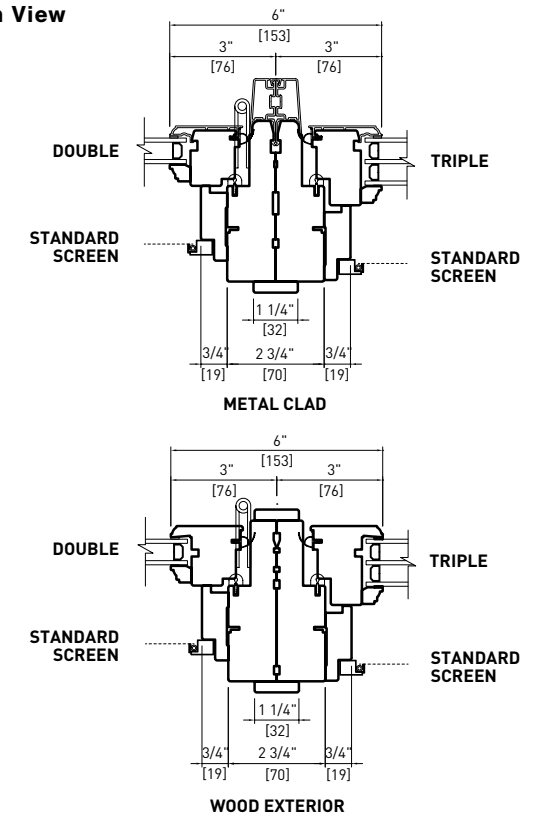

Note: • Other jamb widths available.
• All dimensions to have +/- 1/16" (2mm) tolerance.

Note: • Other jamb widths available.
• All dimensions to have +/- 1/16" (2mm) tolerance.

Picture And Fixed Casement Window Transoms Detail

Head & Sill Detail

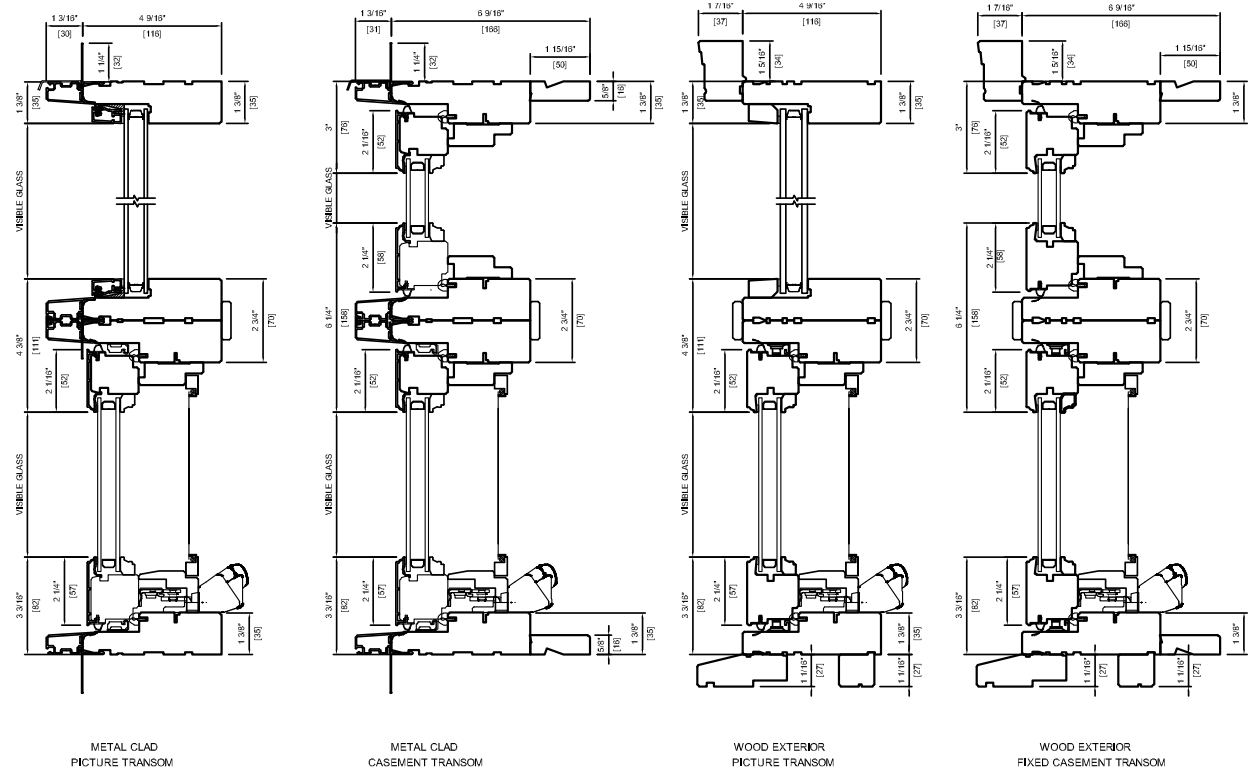

Note: • Other jamb widths available.
• All dimensions to have +/- 1/16" (2mm) tolerance.

Oversized Casement Window (Roto Gear Only) Detail

Head & Sill Detail

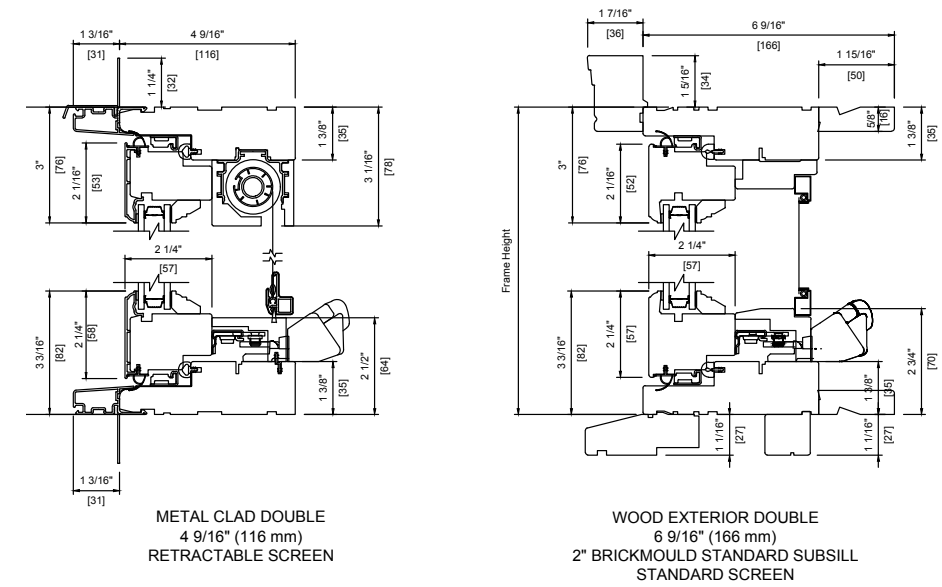

Plan View

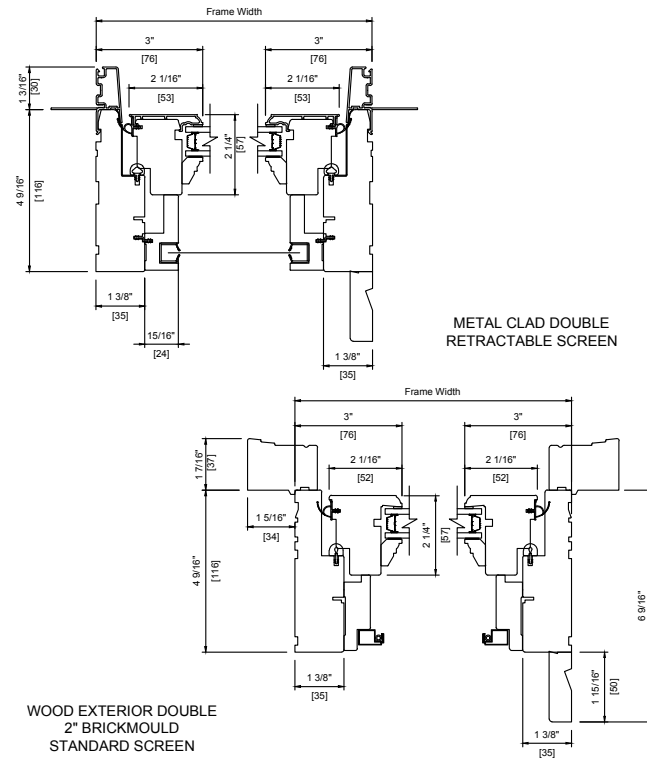

Note: • Other jamb widths available.
• All dimensions to have +/- 1/16" (2mm) tolerance.

Glazing Stop Profiles

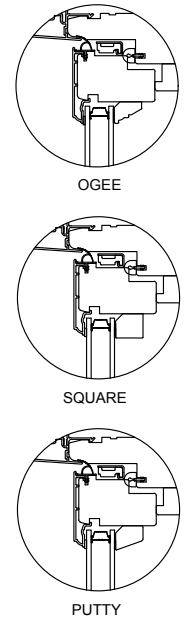

Casing

