



BOW, BAY & CORNER WINDOWS

Technical Guide F

FEATURES & SPECIFICATIONS

Styles

Double Hung, Single Hung and Cottage options.

Standard Features

Natural, clear Douglas Fir interior (no visible finger joints)

4 9/16" (116 mm) jamb construction

LowE insulated glazing with 1/2" (13 mm) airspace

Roto gear operator and concealed sash locks

Extruded aluminum cladding in a variety of standard colors, primed wood or clear fir exterior

Flexible continuous weatherstrip system

Insect screens

Metal handle, cover and locks



Bow



Bay

Hardware

Multiple hardware types and finishes, see section A. Standard awning operator detaches at the sash allowing it to open out to 90 degrees for ease of cleaning. The roto gear operator will hold the sash at any position in its operating radius. The sash is supported by concealed heavy-duty hinges. All awning units are supplied with dual sash locks for added security and tighter seal. All steel components are coated for superior corrosion protection.

Glazing

LowE Double, LowE Triple, Tranquility® and StormForce™. StormForce is not available on all products. Double or triple glass configurations with 1/2" (13 mm) airspace. With countless glazing configurations and LowE coating options, we ensure that you can choose the perfect blend of protection and comfort. LowE best describes the benefits of the product that incorporates glazing coatings and Argon gas. LowE systems help reduce heating and cooling costs, providing superior energy efficiency.

FEATURES & SPECIFICATIONS

Simulated Divided Lites (SDL)

Standard SDL complete with airspace grilles, where available. Grille bars are permanently applied to the interior and exterior.

Ogee Profile – 3/4" (19 mm), 1 1/8" (30 mm), 2" (51 mm)

Putty Profile – 5/8" (16 mm), 7/8" (22 mm), 1 1/8" (30 mm), 2" (51 mm)

Square Profile (interior only) – 5/8" (16mm), 3/4" (19 mm), 7/8" (22 mm), 1 1/8" (30 mm), 2" (51 mm)

Casing

Wood: 2" (51 mm) Brickmould, 3 1/2" (89 mm) Flat, 5 1/2" (139 mm) Flat, Adams and Williamsburg.

Metal Clad: 2" (51 mm) Brickmould, 3 1/2" (89 mm) Flat, 2" clad frame extension, Nose & Cove, Adams, Williamsburg and Kerf.

Metal Cladding

Heavy duty exterior metal cladding comprised of extruded aluminum is available in a variety of Palette colors, including anodized and Cyprium (copper and bronze cladding). Metal clad units are supplied ready-to-install complete with integral metal nailing flange.

Wood

In addition to our standard Coastal Douglas Fir, the entire Loewen product line is also available in optional Mahogany. The interior can be natural wood (unfinished), primed, or prefinished in Jet Black or Oxford White paint. Additional wood species, as well as the Jet Black and Oxford White prefinishes, are available through our Custom Shop. All wood parts are dipped in approved preservative.

Performance Standards

Most units have been tested by an independent laboratory for air and water infiltration, structural performance, and thermal performance requirements.

Frame & Sash

Manufactured from Coastal Douglas Fir kiln-dried lumber with frame construction designed for 4 9/16" (116 mm) jamb. All wood exterior components are factory primed unless specified as clear exterior. Minor scratches or abrasions in the wood surface or primer are not considered defects.

Double Weatherstrip

The combination of a continuous, flexible foam weatherstrip and a flexible automotive type bulb weatherstrip ensures maximum energy efficiency and protection against air and water infiltration.

FEATURES & SPECIFICATIONS

Screen

Screens available in Alpine White, White, Linen, Tuscany Brown, Midnight Bronze, Steel Matte Black, Bronze, or Brushed Aluminum frame, screened with anti-glare fiberglass cloth. Wood-framed screens and High Transparency mesh available. Optional Retractable Screen and Swinging Screen available. Swinging Screen available on Push Out models only.

Egress

Consult local building codes for confirmation of size requirements for your area. Special egress hardware is available for Casement windows, which enables some sizes to meet egress codes, eliminating the need to go to the next larger size window. Consult your Authorized Loewen Dealer for more details.

Visit the Loewen Photo Gallery online at www.loewen.com for a large collection of Loewen product and elevation photography.

Numerous custom window configuration opportunities exist – please contact your Authorized Loewen Dealer.

Specifications and technical information are subject to change without notice. Imperial and metric measurements are converted accurately. However, in some cases, industry standards cause a 1 mm variance. (Example: 3/4" is shown as 19 mm for all glass measurements.) Cad Download: www.loewen.com/architect | Installation Instructions: www.loewen.com

**Bow & Bay (Framed Wall)
Window Sizes**

			Width							
			34' Kitchen Bay			34' Bay				
Rough Opening			57 3/8 [1458]	65 1/4 [1658]	73 1/8 [1858]	94 1/8 [2390]	101 15/16 [2590]	109 13/16 [2790]	117 11/16 [2990]	
Frame			54 13/16 [1393]	62 11/16 [1593]	70 9/16 [1793]	92 1/2 [2325]	99 3/8 [2525]	107 1/4 [2725]	115 1/8 [2925]	
			Projections: Framed Wall 2 X 4 = 10 9/16" (268mm) 2 X 6 = 10 9/16" (268mm)			Projections: Framed Wall 2 x 4 = 14 15/16" (380mm) 2 x 6 = 14 15/16" (380mm)				
Wood Exterior	Metal Clad		15 3/4 - 23 5/8 - 15 3/4 [400 - 600 - 400]	12 1/2 - 31 1/2 - 12 1/2 [400 - 800 - 400]	15 3/4 - 39 3/8 - 15 3/4 [400 - 1000 - 400]	23 5/8 - 47 1/4 - 23 5/8 [600 - 1200 - 600]	23 5/8 - 55 1/8 - 23 5/8 [600 - 1400 - 600]	23 5/8 - 63 - 23 5/8 [600 - 1600 - 600]	23 5/8 - 70 7/8 - 23 5/8 [600 - 1800 - 600]	
36 7/8 [936]	36 3/16 [919]	35 7/16 [900]	BY3 1409	BY3 1609	BY3 1809					
40 13/16 [1036]	40 1/8 [1019]	39 3/8 [1000]	BY3 1410	BY3 1610	BY3 1810					
48 11/16 [1236]	48 [1219]	47 1/4 [1200]				BY3 2412	BY3 2612	BY3 2812	BY3 3012	
56 9/16 [1436]	55 7/8 [1419]	55 1/8 [1400]				BY3 2414	BY3 2614	BY3 2814	BY3 3014	
60 1/2 [1536]	59 13/16 [1519]	59 1/16 [1500]				BY3 2415	BY3 2615	BY3 2815	BY3 3015	
64 7/16 [1636]	63 3/4 [1619]	63 [1600]				BY3 2416	BY3 2616	BY3 2816	BY3 3016	
72 5/16 [1836]	71 5/8 [1819]	70 7/8 [1800]				BY3 2418	BY3 2618	BY3 2818	BY3 3018	

Product Code

¹ Wood Exterior:
Requires additional 3/4" (19mm) for optional head

Glass Size = Visible Glass + 15/16" (24 mm)

² Metal Clad:
Requires additional 3/4" (19mm) for optional head
Requires additional 3/4" (19mm) for optional seat

Standard sizes Shown. Additional sizes may be available. Custom sizes can be ordered.

Note: • For glass sizes, see Casement section.
• For Masonry opening information see section A.

**Bow & Bay (Framed Wall)
Window Sizes**

			Width							
			45' Kitchen Bay			45' Bay				
Rough Opening			54 5/16 [1380]	62 3/16 [1580]	70 1/16 [1780]	89 1/8 [2263]	96 15/16 [2463]	104 13/16 [2663]	112 11/16 [2863]	
Frame			52 3/8 [1330]	60 1/4 [1530]	68 1/8 [1730]	87 1/8 [2213]	95 [2413]	102 7/8 [2613]	110 3/4 [2813]	
			Projections: Framed Wall 2 X 4 = 10 9/16" (268mm) 2 X 6 = 10 9/16" (268mm)			Projections: Framed Wall 2 x 4 = 14 15/16" (380mm) 2 x 6 = 14 15/16" (380mm)				
Wood Exterior	Metal Clad		15 3/4 - 23 5/8 - 15 3/4 [400 - 600 - 400]	12 1/2 - 31 1/2 - 12 1/2 [400 - 800 - 400]	15 3/4 - 39 3/8 - 15 3/4 [400 - 1000 - 400]	23 5/8 - 47 1/4 - 23 5/8 [600 - 1200 - 600]	23 5/8 - 55 1/8 - 23 5/8 [600 - 1400 - 600]	23 5/8 - 63 - 23 5/8 [600 - 1600 - 600]	23 5/8 - 70 7/8 - 23 5/8 [600 - 1800 - 600]	
36 7/8 [936]	36 3/16 [919]	35 7/16 [900]	BY3 1409	BY3 1609	BY3 1809					
40 13/16 [1036]	40 1/8 [1019]	39 3/8 [1000]	BY3 1410	BY3 1610	BY3 1810					
48 11/16 [1236]	48 [1219]	47 1/4 [1200]				BY3 2412	BY3 2612	BY3 2812	BY3 3012	
56 9/16 [1436]	55 7/8 [1419]	55 1/8 [1400]				BY3 2414	BY3 2614	BY3 2814	BY3 3014	
60 1/2 [1536]	59 13/16 [1519]	59 1/16 [1500]				BY3 2415	BY3 2615	BY3 2815	BY3 3015	
64 7/16 [1636]	63 3/4 [1619]	63 [1600]				BY3 2416	BY3 2616	BY3 2816	BY3 3016	
72 5/16 [1836]	71 5/8 [1819]	70 7/8 [1800]				BY3 2418	BY3 2618	BY3 2818	BY3 3018	

Product Code

¹ Wood Exterior:
Requires additional 3/4" (19mm) for optional head

Glass Size = Visible Glass + 15/16" (24 mm)

² Metal Clad:
Requires additional 3/4" (19mm) for optional head
Requires additional 3/4" (19mm) for optional seat

Standard sizes Shown. Additional sizes may be available. Custom sizes can be ordered.

Note: • For glass sizes, see Casement section.
• For Masonry opening information see section A.

Bow & Bay (Framed Wall) Window Sizes

			Width	
			10' Bow	
Rough Opening			98 7/16 [2501]	120 7/8 [3071]
	Frame		95 1/16 [2415]	117 11/16 [2989]
			Projections: Framed Wall 2 x 4 = 8 13/16" (223mm) 2 x 6 = 8 13/16" (223mm)	Projections: Framed Wall 2 x 4 = 13 1/16" (332mm) 2 x 6 = 13 1/16" (332mm)
			23 5/8 - 23 5/8 - 23 5/8 - 23 5/8 [600 - 600 - 600 - 600]	23 5/8 - 23 5/8 - 23 5/8 - 23 5/8 - 23 5/8 [600 - 600 - 600 - 600 - 600]
Wood Exterior	Metal Clad	Frame		
36 7/8 [936]	36 3/16 [919]	35 7/16 [900]	BY4 2409	BY5 3009
40 13/16 [1036]	40 1/8 [1019]	39 3/8 [1000]	BY4 2410	BY5 3010
48 11/16 [1236]	48 [1219]	47 1/4 [1200]	BY4 2412	BY5 3012
56 9/16 [1436]	55 7/8 [1419]	55 1/8 [1400]	BY4 2414	BY5 3014
60 1/2 [1536]	59 13/16 [1519]	59 1/16 [1500]	BY4 2415	BY5 3015
64 7/16 [1636]	63 3/4 [1619]	63 [1600]	BY4 2416	BY5 3016
72 5/16 [1836]	71 5/8 [1819]	70 7/8 [1800]	BY4 2418	BY5 3018
			Product Code	

Height

Glass Size = Visible Glass + 15/16" (24 mm)

¹ Wood Exterior:
Requires additional 3/4" (19mm) for optional head

² Metal Clad:
Requires additional 3/4" (19mm) for optional head
Requires additional 3/4" (19mm) for optional seat

Standard sizes Shown. Additional sizes may be available. Custom sizes can be ordered.

Note: • For glass sizes, see Casement section.
• For Masonry opening information see section A.

Bow & Bay (Framed Wall) Window Detail

Framed Wall Bay Construction Detail

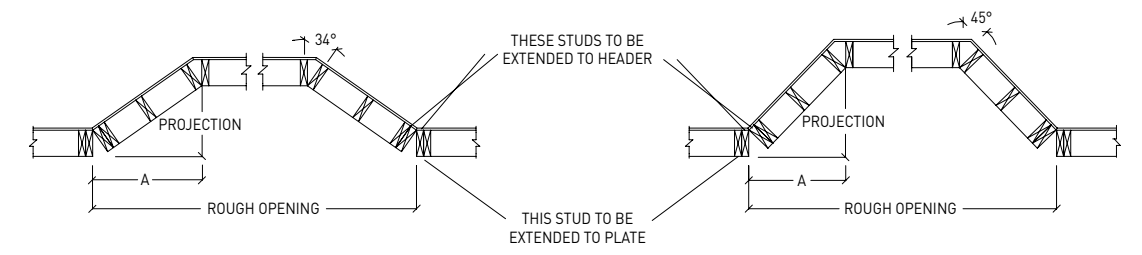

34° Framing Measurements – 23 5/8" (600 mm) Flankers				
DESCRIPTION	4 9/16" (116 mm) JAMB		6 9/16" (166 mm) JAMB	
	in.	mm	in.	mm
A MEASUREMENT	23 1/4"	591	23 7/8"	606
PROJECTION	14 15/16"	380	14 15/16"	380

45° Framing Measurements – 23 5/8" (600 mm) Flankers				
DESCRIPTION	4 9/16" (116 mm) JAMB		6 9/16" (166 mm) JAMB	
	in.	mm	in.	mm
A MEASUREMENT	20 11/16"	526	21 9/16"	547
PROJECTION	19 3/16"	488	19 3/16"	488

Note: • Framed Wall Bay windows are supplied without head and seat.

Framed Wall Bow Construction Detail

Four Section Bow Window

Framing Measurements for Standard 23 5/8" (600 mm) Units				
DESCRIPTION	4 9/16" (116 mm) JAMB		6 9/16" (166 mm) JAMB	
	in.	mm	in.	mm
ROUGH OPENING WIDTH	98 7/16"	2500	98 7/16"	2500
HEADER LENGTH	101 7/16"	2576	101 7/16"	2576
A MEASUREMENT	25 5/8"	651	25 15/16"	659
B MEASUREMENT	6 3/4"	171	6 3/4"	172
C MEASUREMENT	49 3/16"	1250	49 3/16"	1250
D MEASUREMENT	8 13/16"	224	8 3/4"	223

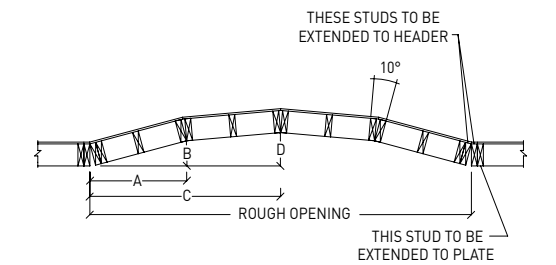

Five Section Bow Window

Framing Measurements for Standard 23 5/8" (600 mm) Units				
DESCRIPTION	4 9/16" (116 mm) JAMB		6 9/16" (166 mm) JAMB	
	in.	mm	in.	mm
ROUGH OPENING WIDTH	120 13/16"	3069	120 13/16"	3069
HEADER LENGTH	123 13/16"	3145	123 13/16"	3145
A MEASUREMENT	25 1/4"	641	25 3/4"	654
B MEASUREMENT	8 15/16"	227	9"	229
C MEASUREMENT	48 9/16"	1234	48 3/4"	1238
D MEASUREMENT	13 1/16"	332	13 1/16"	332

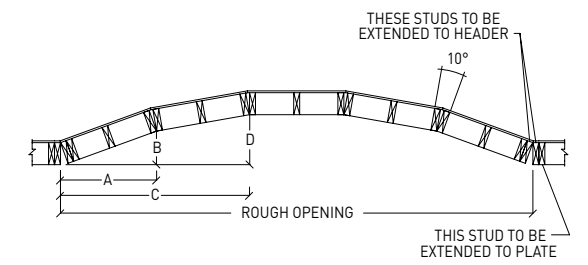

Note: • Other jamb widths available.
• All dimensions to have +/- 1/16" (2mm) tolerance.

34° Framed Wall Bay Window Detail

Plan View

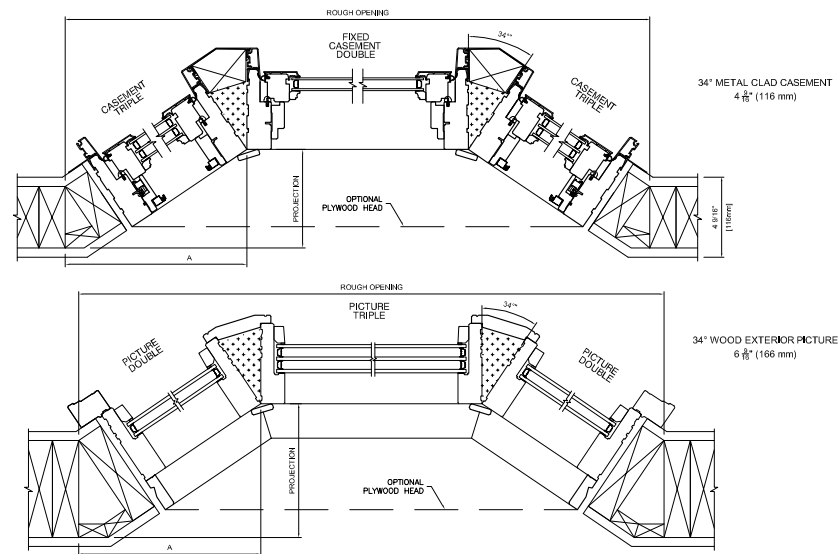

Note: • For projection dimensions, refer to Framed Wall Bow elevations.

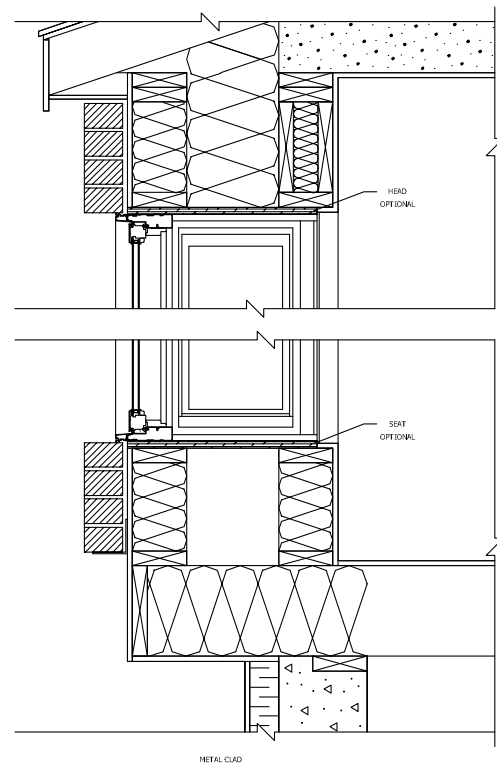

Plan View

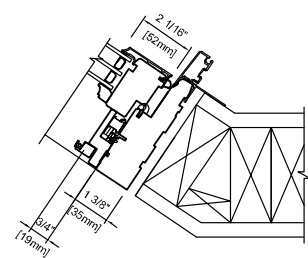

FRAMED WALL METAL CLAD CASEMENT
4 9/16\" (116 mm) JAMB

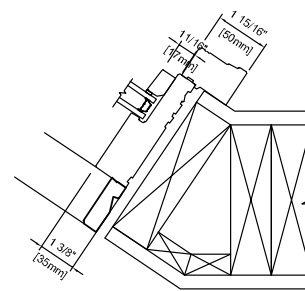

FRAMED WALL WOOD PICTURE
6 9/16\" (166 mm) JAMB

Note: • Other jamb widths available.
• All dimensions to have +/- 1/16\" (2mm) tolerance.

45° Framed Wall Bay Window Detail

Plan View

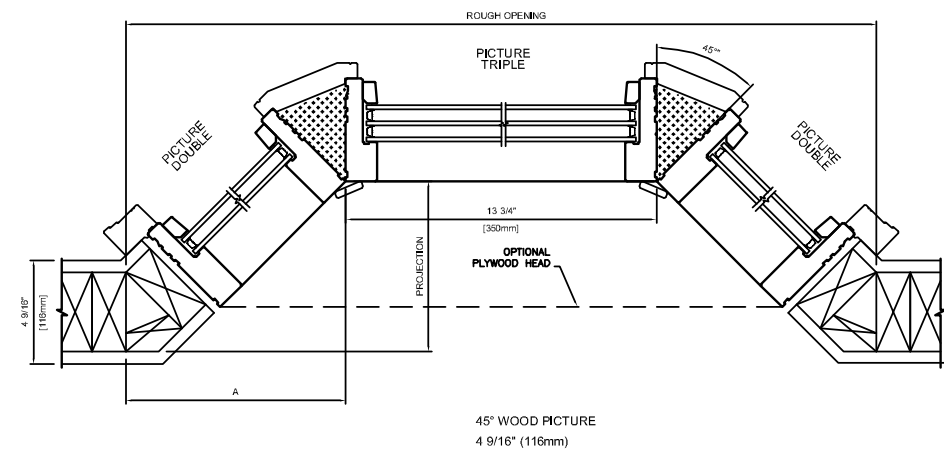
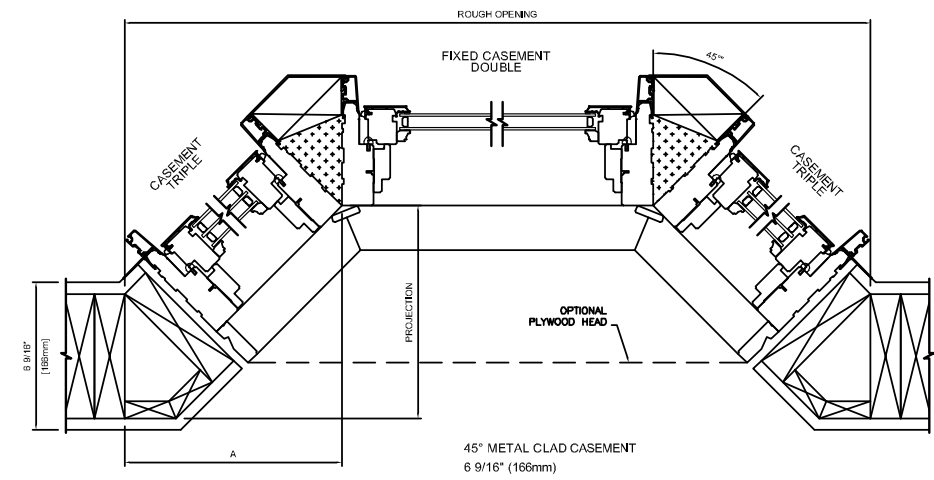

Plan View

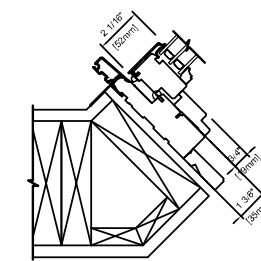

45° METAL CLAD CASEMENT
6 9/16\" (166mm)

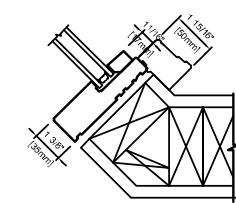

45° WOOD PICTURE
4 9/16\" (116mm)

Note: • Other jamb widths available.
• All dimensions to have +/- 1/16\" (2mm) tolerance.

10° Framed Wall Bow Window Detail

Plan View

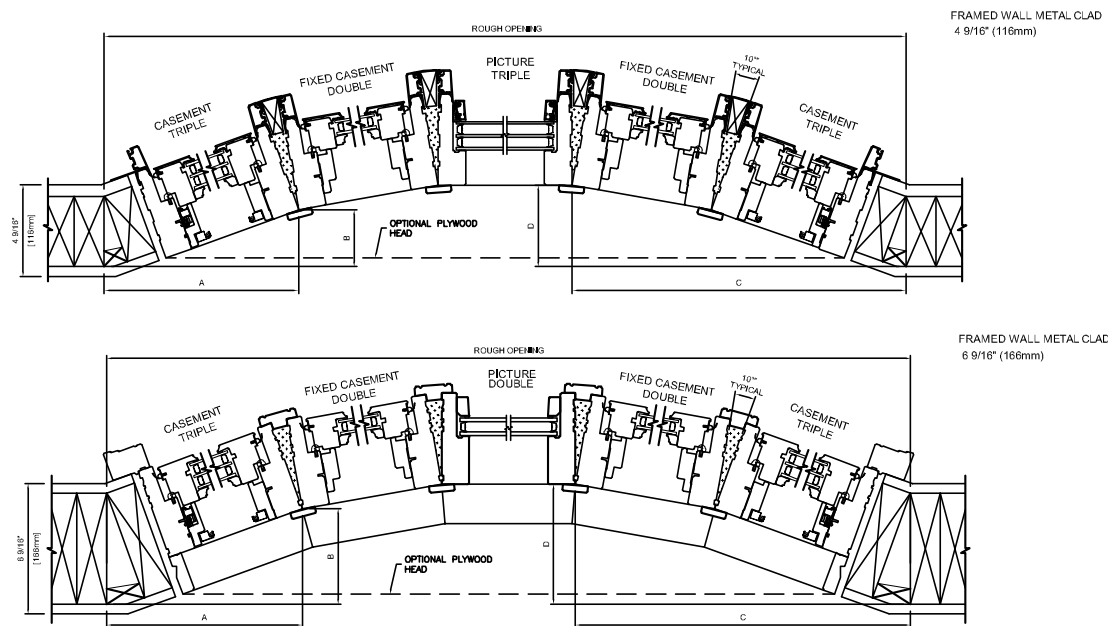

Note: • Also available in a four-wide unit.
• For projection dimensions, refer to Framed Wall Bow elevation

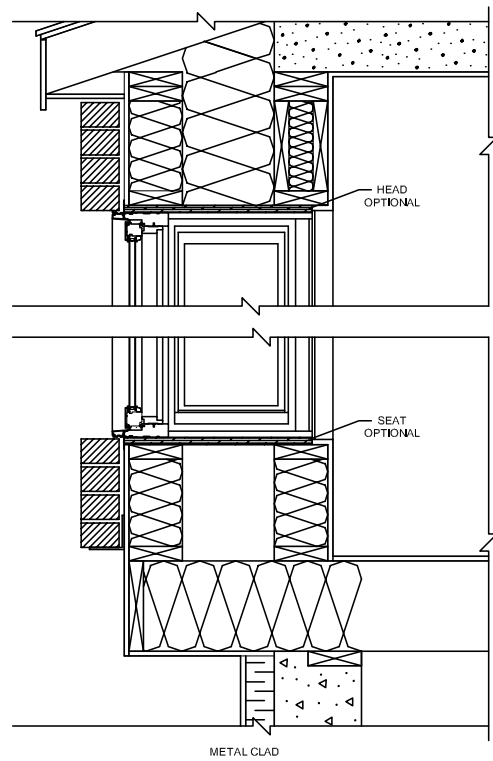

Plan View

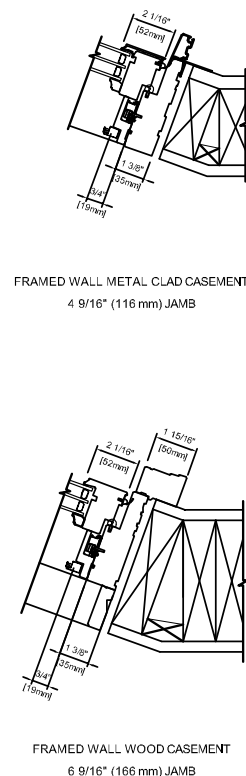

Note: • Other jamb widths available.
• All dimensions to have +/- 1/16" (2mm) tolerance.

Bow & Bay (Straight Wall) Window Sizes

			Width						
			34' Kitchen Bay		34' Bay				
Rough Opening			54 1/2 [1384]	62 3/8 [1589]	70 1/4 [1784]	91 3/16 [2316]	99 1/16 [2516]	106 15/16 [2716]	114 13/16 [2916]
	Frame		54 13/16 [1393]	62 11/16 [1593]	70 9/16 [1793]	91 1/2 [2325]	99 3/8 [2525]	107 1/4 [2725]	115 1/8 [2925]
		Projections: Straight Wall 2 x 4 = 9 13/16" (250mm) 2 x 6 = 11 13/16" (300mm)			Projections: Straight Wall 2 x 4 = 14 1/4" (362mm) 2 x 6 = 16 1/4" (412mm)				
Wood Exterior	Metal Clad		15 3/4 - 23 5/8 - 15 3/4 [400 - 600 - 400]	12 1/2 - 31 1/2 - 12 1/2 [400 - 800 - 400]	15 3/4 - 39 3/8 - 15 3/4 [400 - 1000 - 400]	23 5/8 - 47 1/4 - 23 5/8 [600 - 1200 - 600]	23 5/8 - 55 1/8 - 23 5/8 [600 - 1400 - 600]	23 5/8 - 63 - 23 5/8 [600 - 1600 - 600]	23 5/8 - 70 7/8 - 23 5/8 [600 - 1800 - 600]
36 7/8 [936]	36 3/16 [919]	35 7/16 [900]	BY3 1409	BY3 1609	BY3 1809				
40 13/16 [1036]	40 1/8 [1019]	39 3/8 [1000]	BY3 1410	BY3 1610	BY3 1810				
48 11/16 [1236]	48 [1219]	47 1/4 [1200]				BY3 2412	BY3 2612	BY3 2812	BY3 3012
56 9/16 [1436]	55 7/8 [1419]	55 1/8 [1400]				BY3 2414	BY3 2614	BY3 2814	BY3 3014
60 1/2 [1536]	59 13/16 [1519]	59 1/16 [1500]				BY3 2415	BY3 2615	BY3 2815	BY3 3015
64 7/16 [1636]	63 3/4 [1619]	63 [1600]				BY3 2416	BY3 2616	BY3 2816	BY3 3016
72 5/16 [1836]	71 5/8 [1819]	70 7/8 [1800]				BY3 2418	BY3 2618	BY3 2818	BY3 3018

Height

Product Code

¹ Wood Exterior:
Requires additional 3/4" (19mm) for optional head

Glass Size = Visible Glass + 15/16" (24 mm)

² Metal Clad:
Requires additional 3/4" (19mm) for optional head
Requires additional 3/4" (19mm) for optional seat

Standard sizes Shown. Additional sizes may be available. Custom sizes can be ordered.

Note: • For glass sizes, see Casement section.

**Bow & Bay (Straight Wall)
Window Sizes**

			Width										
			45° Kitchen Bay		45° Bay								
Rough Opening			51 1/8 [1298]	59 [1498]	66 7/8 [1698]	85 7/8 [2181]	93 3/4 [2381]	101 5/8 [2581]	109 1/2 [2781]				
	Wood Exterior	Metal Clad	Frame		52 3/8 [1330]	60 1/4 [1530]	68 1/8 [1730]	87 1/8 [2213]	95 [2413]	102 7/8 [2613]	110 3/4 [2813]		
			Projections: Straight Wall 2 x 4 = 12 15/16" (329mm) 2 x 6 = 14 15/16" (379mm)				Projections: Straight Wall 2 x 4 = 18 1/2" (470mm) 2 x 6 = 20 1/2" (520mm)						
			15 3/4 - 23 5/8 - 15 3/4 [400 - 600 - 400]		12 1/2 - 31 1/2 - 12 1/2 [400 - 800 - 400]		15 3/4 - 39 3/8 - 15 3/4 [400 - 1000 - 400]		23 5/8 - 47 1/4 - 23 5/8 [600 - 1200 - 600]		23 5/8 - 55 1/8 - 23 5/8 [600 - 1400 - 600]		23 5/8 - 63 - 23 5/8 [600 - 1600 - 600]
Height													
36 7/8 [936]	36 3/16 [919]	35 7/16 [900]	BY3 1409	BY3 1609	BY3 1809								
40 13/16 [1036]	40 1/8 [1019]	39 3/8 [1000]	BY3 1410	BY3 1610	BY3 1810								
48 11/16 [1236]	48 [1219]	47 1/4 [1200]				BY3 2412	BY3 2612	BY3 2812	BY3 3012				
56 9/16 [1436]	55 7/8 [1419]	55 1/8 [1400]				BY3 2414	BY3 2614	BY3 2814	BY3 3014				
60 1/2 [1536]	59 13/16 [1519]	59 1/16 [1500]				BY3 2415	BY3 2615	BY3 2815	BY3 3015				
64 7/16 [1636]	63 3/4 [1619]	63 [1600]				BY3 2416	BY3 2616	BY3 2816	BY3 3016				
72 5/16 [1836]	71 5/8 [1819]	70 7/8 [1800]				BY3 2418	BY3 2618	BY3 2818	BY3 3018				
			Product Code										

¹ Wood Exterior:
Requires additional 3/4" (19mm) for optional head

Glass Size = Visible Glass + 15/16" (24 mm)

² Metal Clad:
Requires additional 3/4" (19mm) for optional head
Requires additional 3/4" (19mm) for optional seat

Standard sizes Shown. Additional sizes may be available. Custom sizes can be ordered.

Note: • For glass sizes, see Casement section.
• For Masonry opening information see section A.

**Bow & Bay (Straight Wall)
Window Sizes**

			Width			
			10° Bow			
Rough Opening			95 [2414]	118 [2997]		
	Wood Exterior	Metal Clad	Frame		94 1/2 [2401]	117 11/16 [2989]
			Projections: Straight Wall 2 x 4 = 8 3/16" (208mm) 2 x 6 = 10 33/16" (258mm)		Projections: Straight Wall 2 x 4 = 12 7/16" (316mm) 2 x 6 = 14 7/16" (366mm)	
			23 5/8 - 23 5/8 - 23 5/8 - 23 5/8 [600 - 600 - 600 - 600]		23 5/8 - 23 5/8 - 23 5/8 - 23 5/8 [600 - 600 - 600 - 600]	
Height						
36 7/8 [936]	36 3/16 [919]	35 7/16 [900]	BY4 2409	BY5 3009		
40 13/16 [1036]	40 1/8 [1019]	39 3/8 [1000]	BY4 2410	BY5 3010		
48 11/16 [1236]	48 [1219]	47 1/4 [1200]	BY4 2412	BY5 3012		
56 9/16 [1436]	55 7/8 [1419]	55 1/8 [1400]	BY4 2414	BY5 3014		
60 1/2 [1536]	59 13/16 [1519]	59 1/16 [1500]	BY4 2415	BY5 3015		
64 7/16 [1636]	63 3/4 [1619]	63 [1600]	BY4 2416	BY5 3016		
72 5/16 [1836]	71 5/8 [1819]	70 7/8 [1800]	BY4 2418	BY5 3018		
			Product Code			

¹ Wood Exterior:
Requires additional 3/4" (19mm) for optional head

Glass Size = Visible Glass + 15/16" (24 mm)

² Metal Clad:
Requires additional 3/4" (19mm) for optional head
Requires additional 3/4" (19mm) for optional seat

Standard sizes Shown. Additional sizes may be available. Custom sizes can be ordered.

Note: • For glass sizes, see Casement section.
• For Masonry opening information see section A.

Bow & Bay (Straight Wall) Window Detail

Straight Wall Bay Construction Details

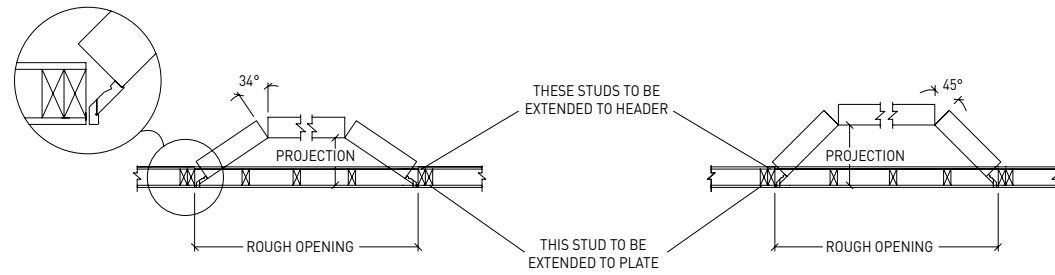

34° Framing Measurements – 15 3/4" (400 mm) Flankers

DESCRIPTION	4 9/16" (116 mm) JAMB		6 9/16" (166 mm) JAMB	
	in.	mm	in.	mm
PROJECTION	9 13/16"	250	11 13/16"	300

45° Framing Measurements – 15 3/4" (400 mm) Flankers

DESCRIPTION	4 9/16" (116 mm) JAMB		6 9/16" (166 mm) JAMB	
	in.	mm	in.	mm
PROJECTION	12 15/16"	329	14 15/16"	379

34° Framing Measurements – 23 5/8" (600 mm) Flankers

DESCRIPTION	4 9/16" (116 mm) JAMB		6 9/16" (166 mm) JAMB	
	in.	mm	in.	mm
PROJECTION	14 1/4"	326	16 1/4"	412

45° Framing Measurements – 23 5/8" (600 mm) Flankers

DESCRIPTION	4 9/16" (116 mm) JAMB		6 9/16" (166 mm) JAMB	
	in.	mm	in.	mm
PROJECTION	18 1/2"	470	20 1/2"	520

Note: • Kitchen and straight wall Bay windows are supplied with a 3/4" (19 mm) head and seat.

34° Straight Wall Bay Window Detail

Plan View

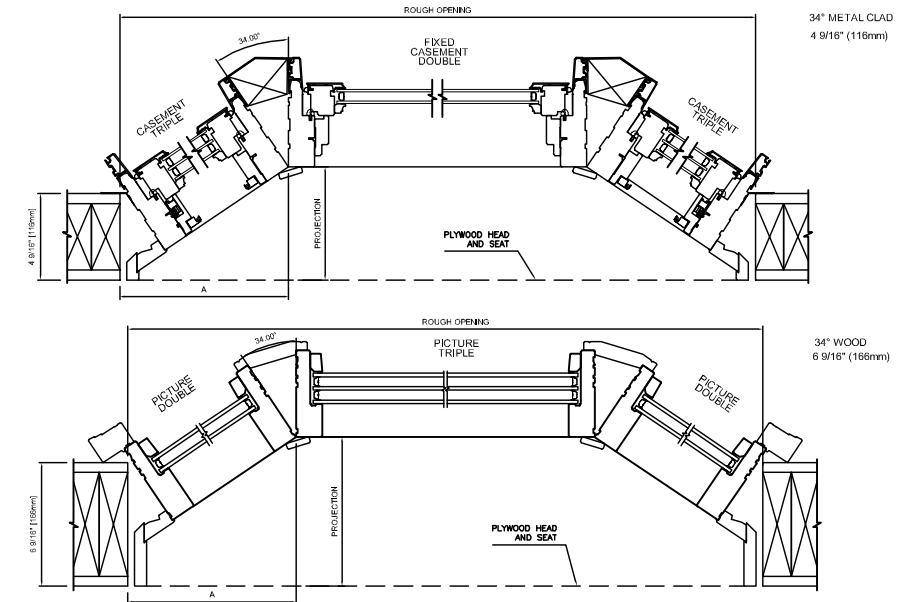

Straight Wall Bow Construction Details

Four Section Bow Window

Framing Measurements For Standard 23 5/8" (600 mm) Units

DESCRIPTION	4 9/16" (116 mm) JAMB		6 9/16" (166 mm) JAMB	
	in.	mm	in.	mm
ROUGH OPENING WIDTH	95 9/16"	2428	95 9/16"	2428
HEADER LENGTH	98 9/16"	2504	98 9/16"	2504
A MEASUREMENT	24 1/4"	616	24 1/4"	616
B MEASUREMENT	6 1/8"	155	8 1/16"	205
C MEASUREMENT	47 3/4"	1214	47 3/4"	1214
D MEASUREMENT	8 3/16"	208	10 3/16"	258

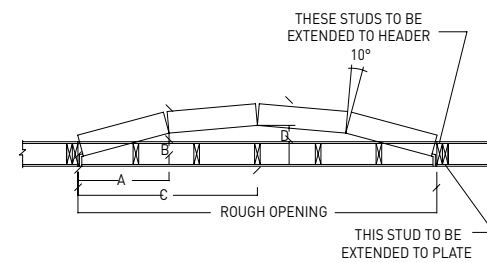

Five Section Bow Window

Framing Measurements For Standard 23 5/8" (600 mm) Units

DESCRIPTION	4 9/16" (116 mm) JAMB		6 9/16" (166 mm) JAMB	
	in.	mm	in.	mm
ROUGH OPENING WIDTH	118"	2997	118"	2997
HEADER LENGTH	121"	3073	121"	3073
A MEASUREMENT	23 15/16"	607	23 15/16"	607
B MEASUREMENT	8 5/16"	212	10 5/16"	262
C MEASUREMENT	47 3/16"	1198	47 3/16"	1198
D MEASUREMENT	12 7/16"	316	14 7/16"	366

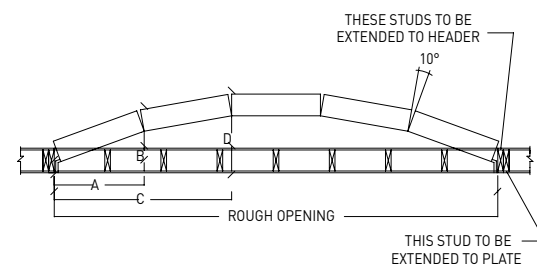

Note: • Other jamb widths available.

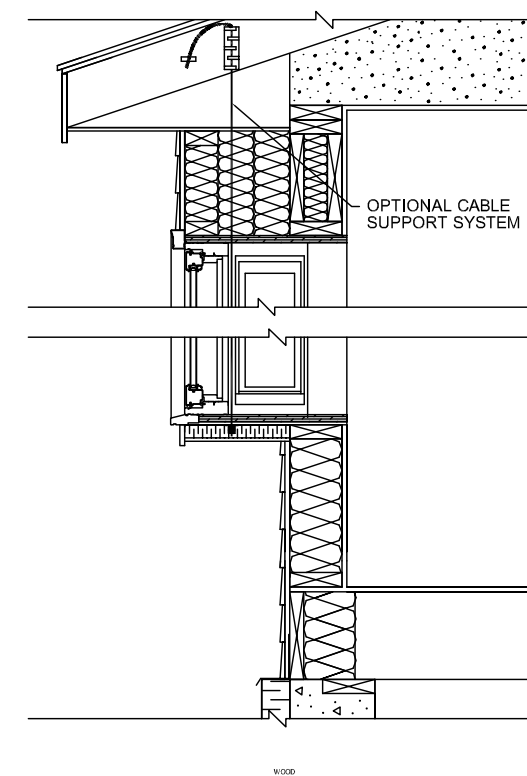

Plan View

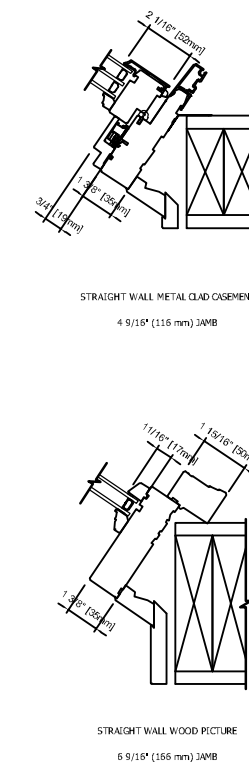

Note: • Other jamb widths available.
• All dimensions to have +/- 1/16" (2mm) tolerance.

45° Straight Wall Bay Window Detail

Plan View

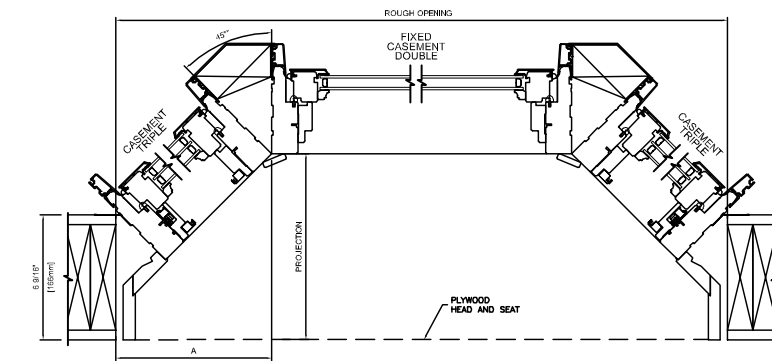

45° METAL CLAD CASERMENT
6 9/16" (166mm)

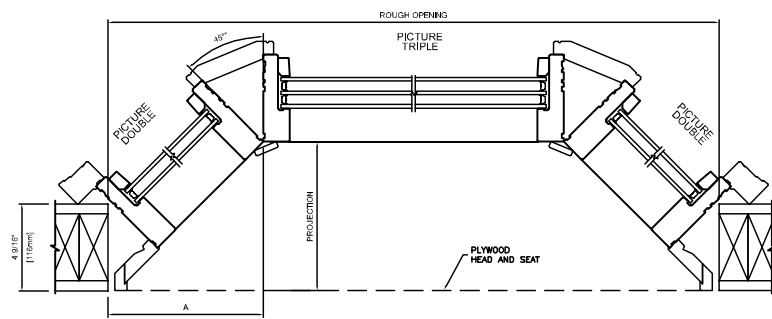

45° WOOD PICTURE
4 9/16" (116mm)

Plan View

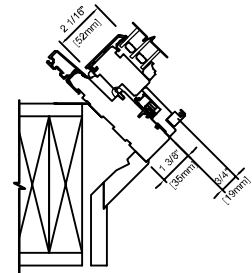

45° METAL CLAD CASERMENT
6 9/16" (166mm)

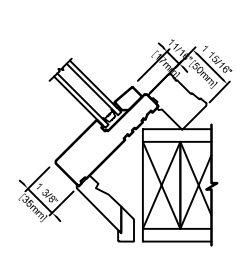

45° WOOD PICTURE
4 9/16" (116mm)

Note: • Other jamb widths available.
• All dimensions to have +/- 1/16" (2mm) tolerance.

10° Straight Wall Bow Window Detail

Plan View

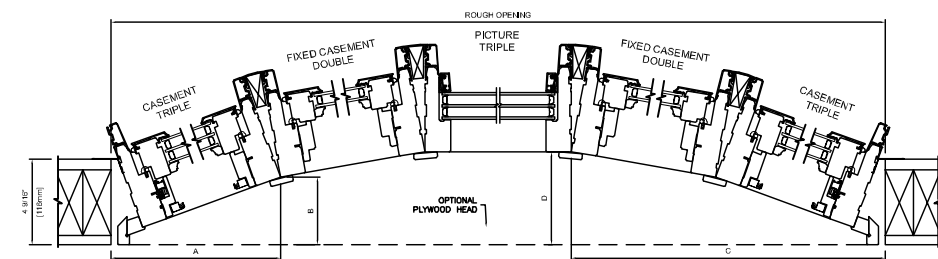

10° METAL CLAD
4 9/16" (116mm)

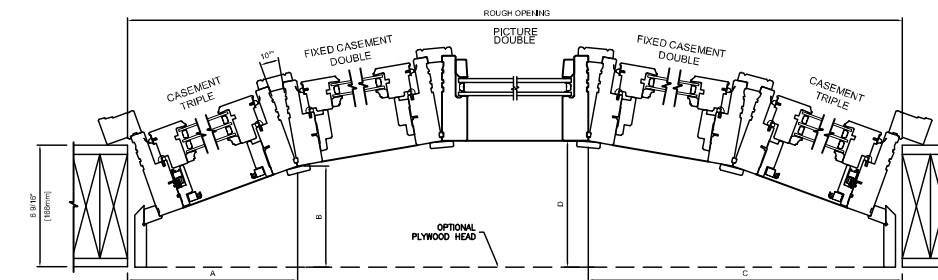

10° WOOD
6 9/16" (166mm)

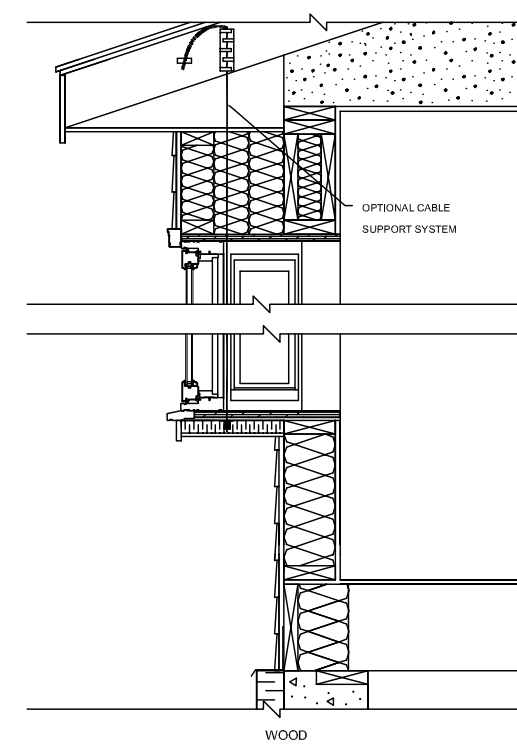

Plan View

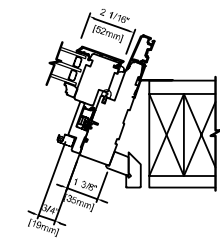

STRAIGHT WALL METAL CLAD CASERMENT
4 9/16" (116 mm) JAMB

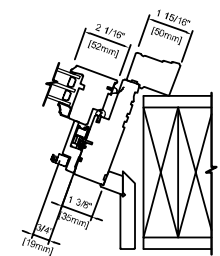

STRAIGHT WALL WOOD CASERMENT
6 9/16" (166 mm) JAMB

Note: • Other jamb widths available.
• All dimensions to have +/- 1/16" (2mm) tolerance.

Picture/Direct Set Corner Window Detail

Head & Sill Detail

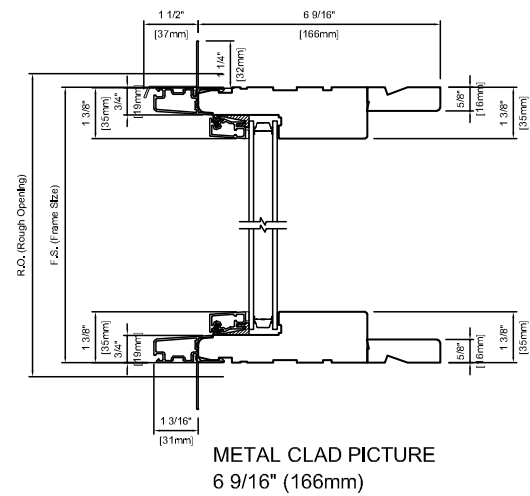

METAL CLAD PICTURE
6 9/16" (166mm)

Note: • CUDSP = Corner Unit Direct Set Post

Plan View

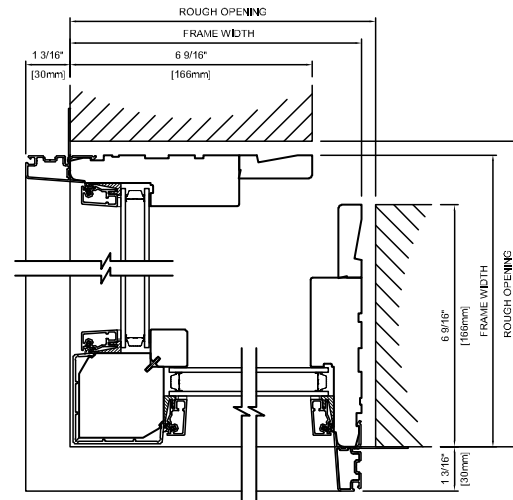

Casement Corner Window Detail

Head & Sill Detail

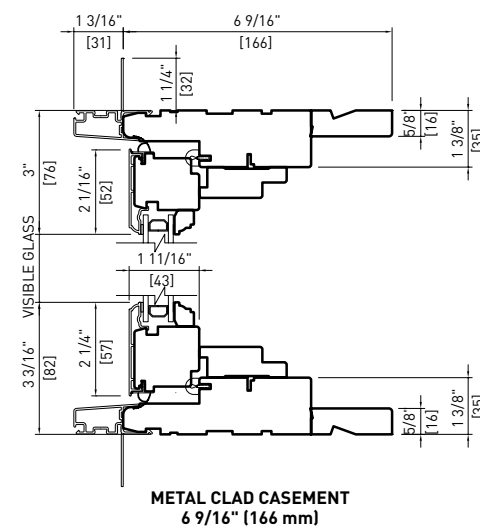

METAL CLAD CASEMENT
6 9/16" (166 mm)

Note: • CUMCS = Corner Unit Mitred Casement Sash.

Plan View

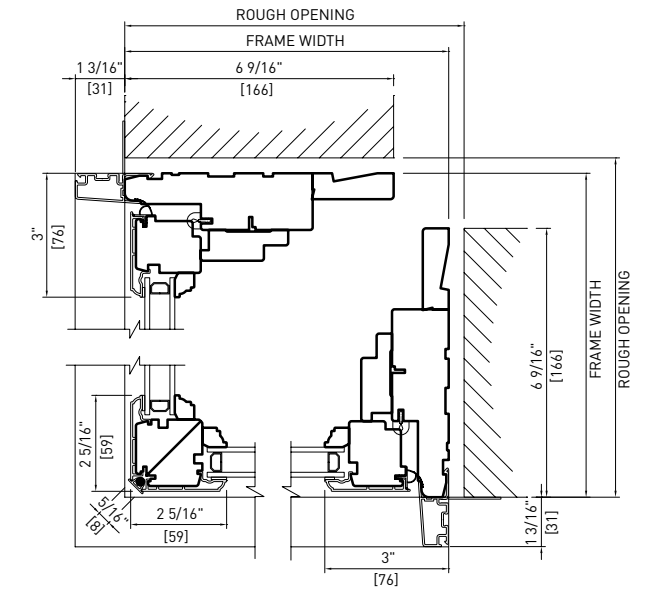

Head & Sill Detail

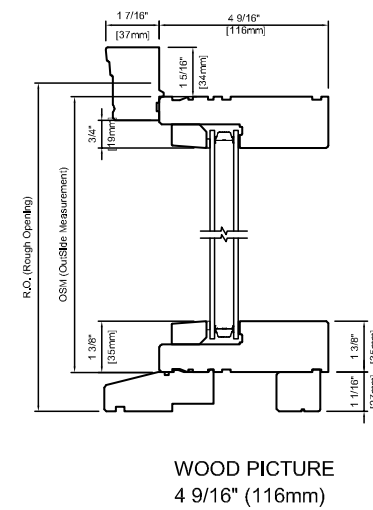

WOOD PICTURE
4 9/16" (116mm)

Note: • Other jamb widths available.
• All dimensions to have +/- 1/16" (2mm) tolerance.

Plan View

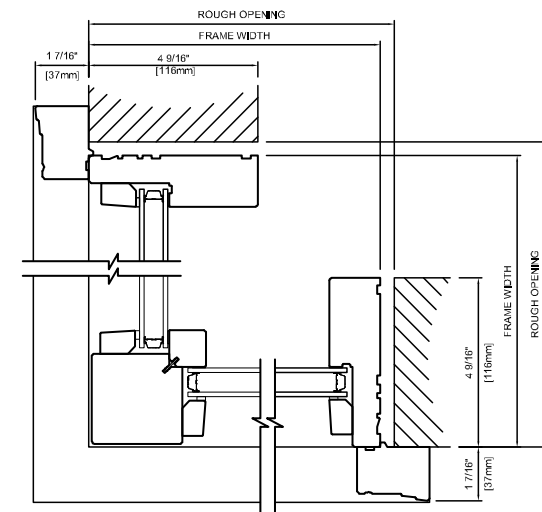

Head & Sill Detail

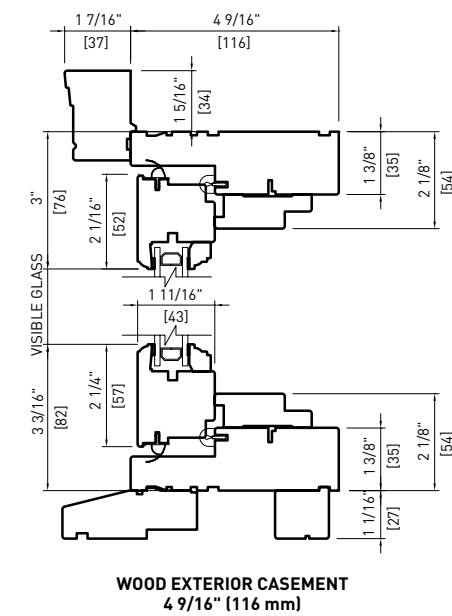

WOOD EXTERIOR CASEMENT
4 9/16" (116 mm)

Note: • Other jamb widths available.
• All dimensions to have +/- 1/16" (2mm) tolerance.

Plan View

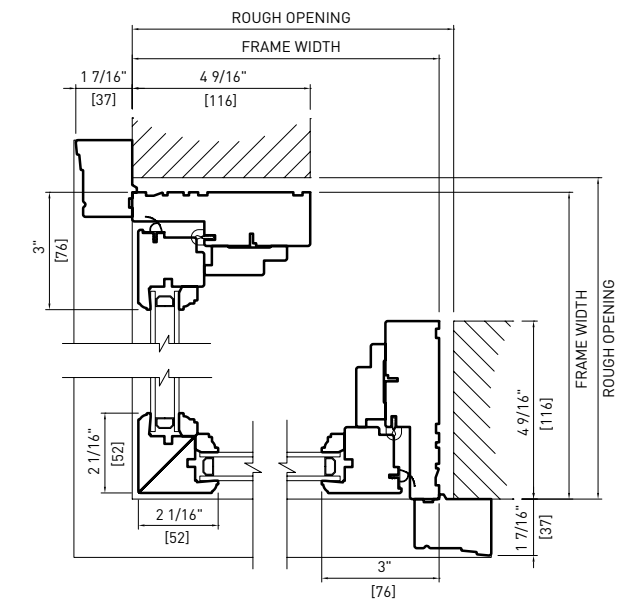

Picture/Direct Set Corner (Butt Glazed) Window Detail

Head & Sill Detail

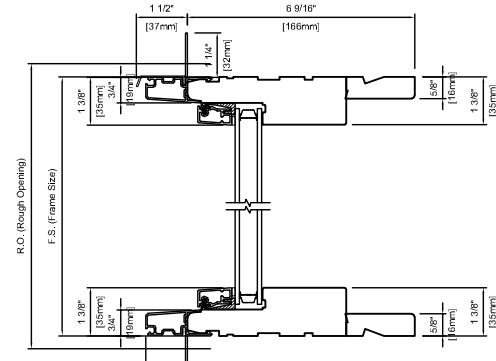

METAL CLAD PICTURE
6 9/16" (166mm)

Plan View

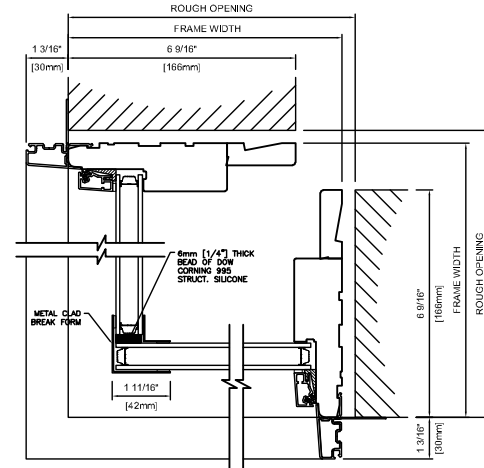

Note: • CUDSBG = Corner Unit Direct Set Butt Glazed.

Casement Corner (Butt Glazed) Window Detail

Head & Sill Detail

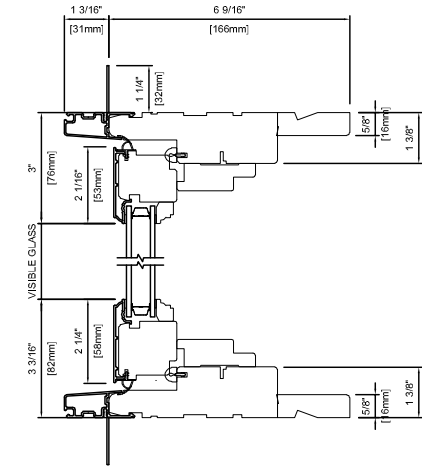

METAL CLAD CASEMENT
6 9/16" (166mm)

Note: • CUSBG = Corner Unit Sashed Butt Glazed.

Plan View

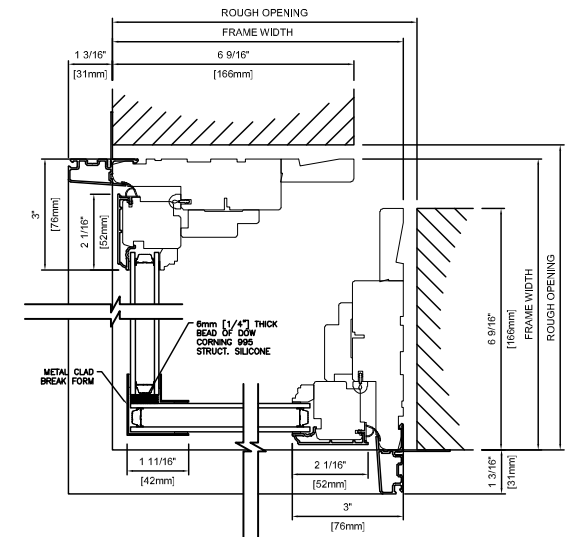

Head & Sill Detail

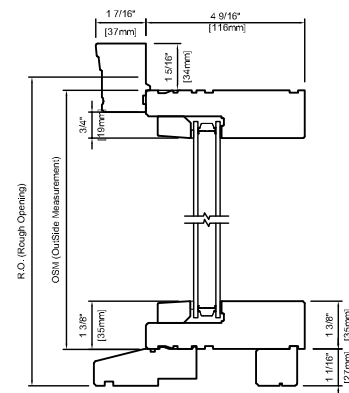

WOOD PICTURE
4 9/16" (116mm)

Plan View

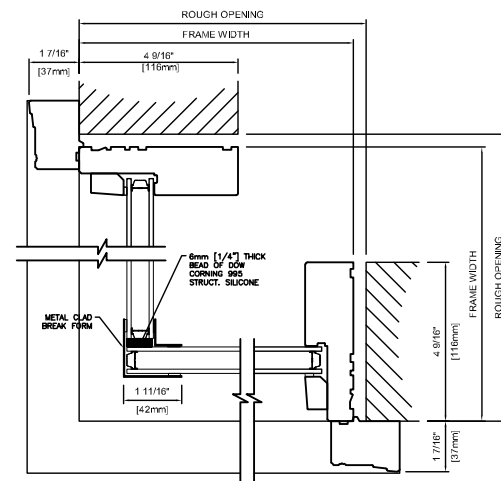

Note: • Other jamb widths available.
• All dimensions to have +/- 1/16" (2mm) tolerance.

Head & Sill Detail

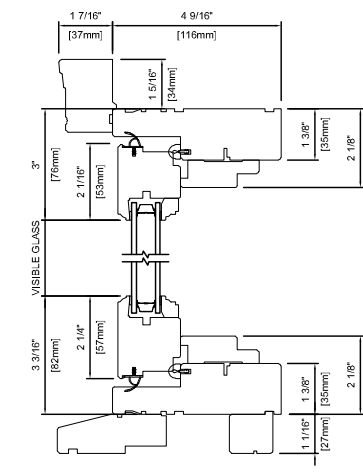

WOOD CASEMENT
4 9/16" (116mm)

Note: • Other jamb widths available.
• All dimensions to have +/- 1/16" (2mm) tolerance.

Plan View

